

Comparison of anchovy abundances estimated by trawls, egg production methods and acoustic surveys.

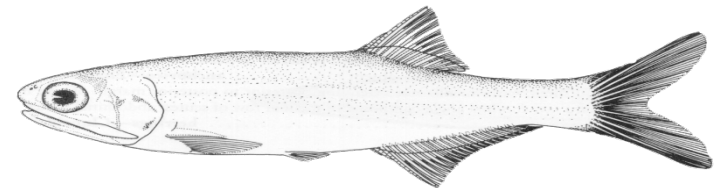
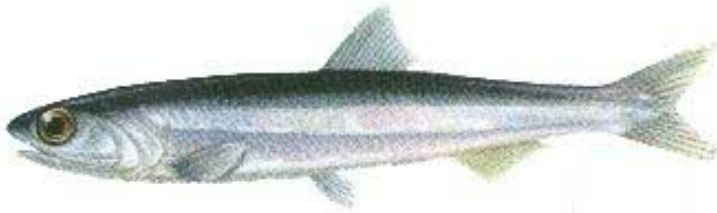

Sukgeun Jung and Edward D. Houde

1. School of Marine Biomedical Sciences, College of Ocean Sciences, Jeju National University, Korea
2. University of Maryland Center for Environmental Science, Chesapeake Biological Laboratory, Solomons, MD, USA

Outline

- Anchovy biomass estimates
 - Korea Strait (Pacific anchovy)
 - Chesapeake Bay, USA (bay anchovy)
- Estimating methods
 - Trawls
 - Egg production method (EPM)
 - Acoustics
- Future works



Common Name	Pacific anchovy	Bay anchovy
Scientific Name	<i>Engraulis japonicus</i>	<i>Anchoa mitchilli</i>
Distribution Area	Northwestern Pacific	Western Atlantic
Study Area	Korea Strait	Chesapeake Bay
Spawning Season	April-August	May-August
Maturation	90 cm FL (7 months)	45-50 cm FL (10 months)
L_∞ (mm FL)	164.4	129.3
Fork length of age-1 individual (mm)	116.2	51.9
Wet weight of age-1 individual (g)	12.30	1.27
Number of batch spawning per year	36	55
Number of eggs produced by a female	159,586	46,229
Length-specific mortality (mm⁻¹ d⁻¹)	1.23	1.17~1.43
Dominance in fish assemblages (biomass)	~15%	~75%

Chesapeake Bay



Stations sampled by the mid-water trawl during 1995 to 2000.

Baywide Survey
(total area = 5,514 km²)

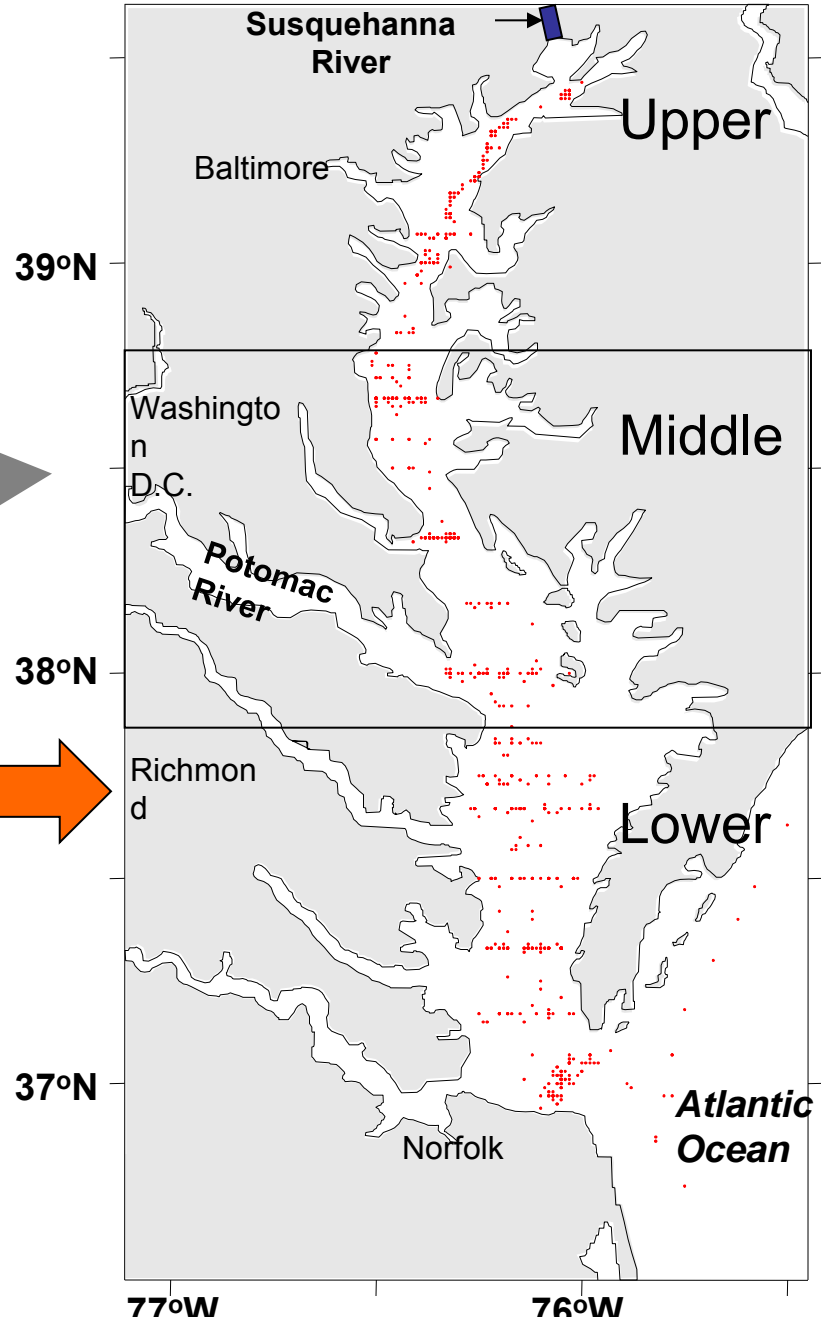
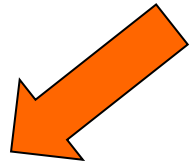
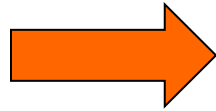

Midwater Trawl

3-mm codend

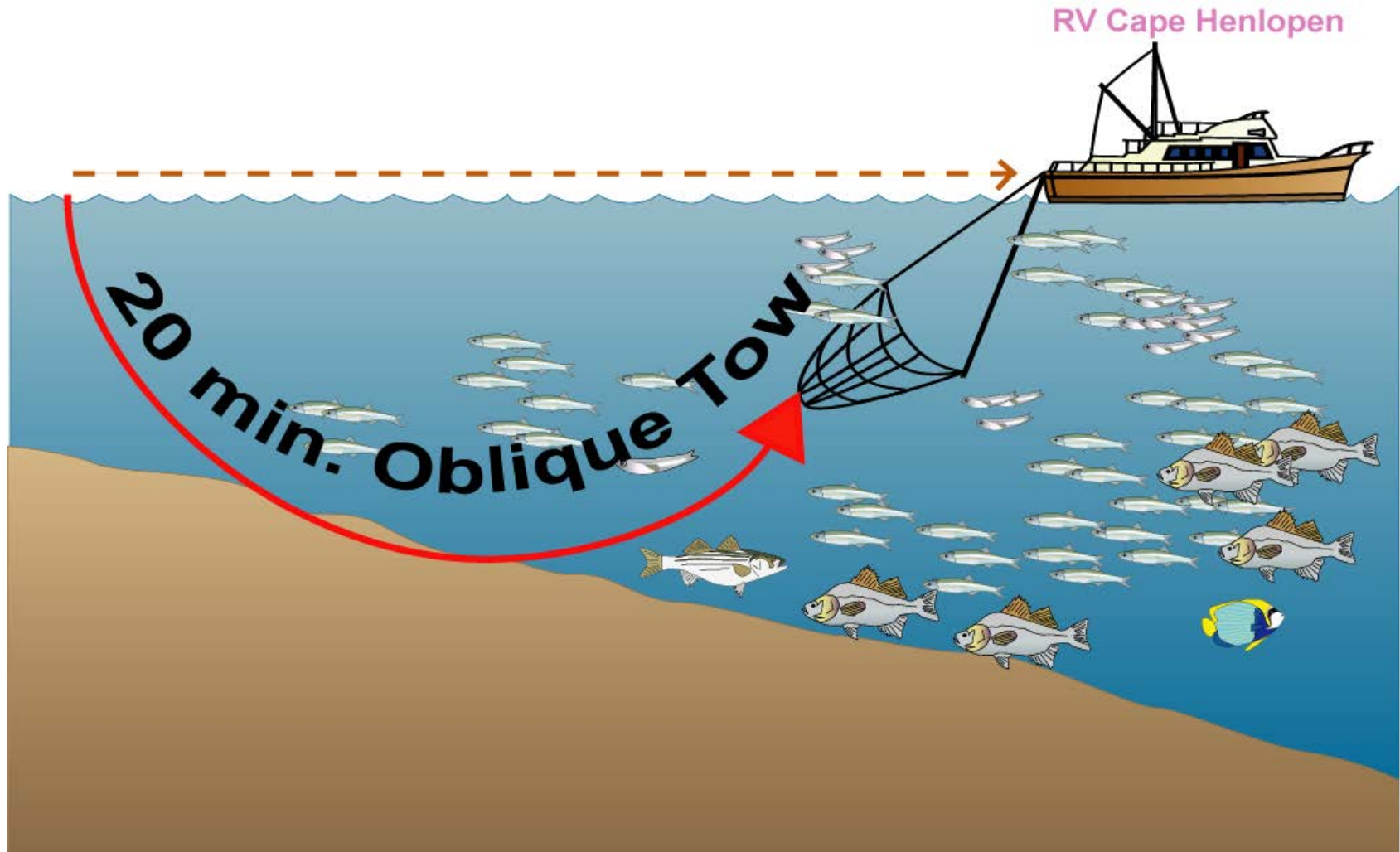

Midwater Trawl Catch

The trawl catches mostly young-of-the-year fishes, and is most effective in sampling pelagic and benthopelagic species.

Prominent in catches are: bay anchovy, blueback herring, alewife, white perch, Atlantic croaker, weakfish, and Atlantic menhaden



Mid-Water Trawl vs. Egg Production Method (EPM)

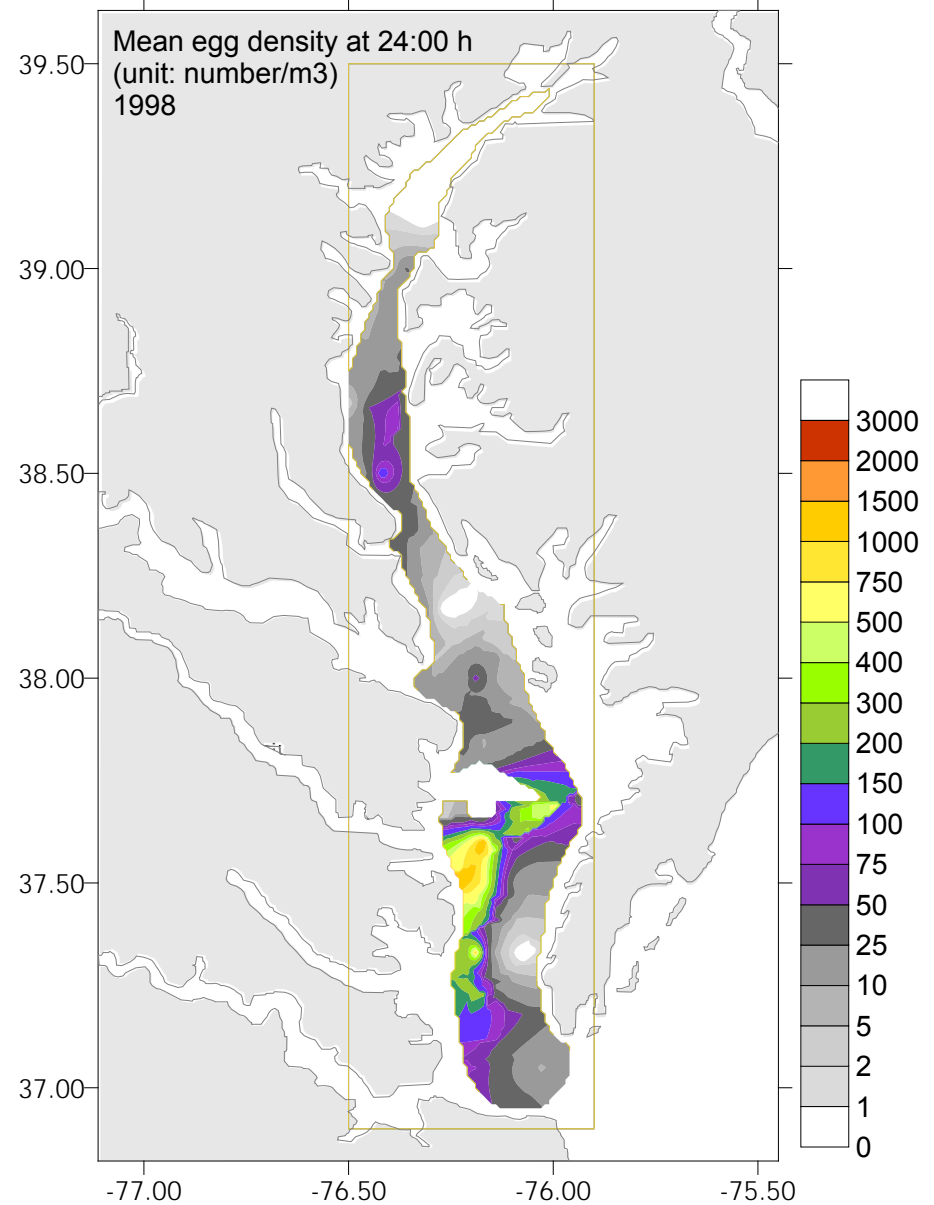
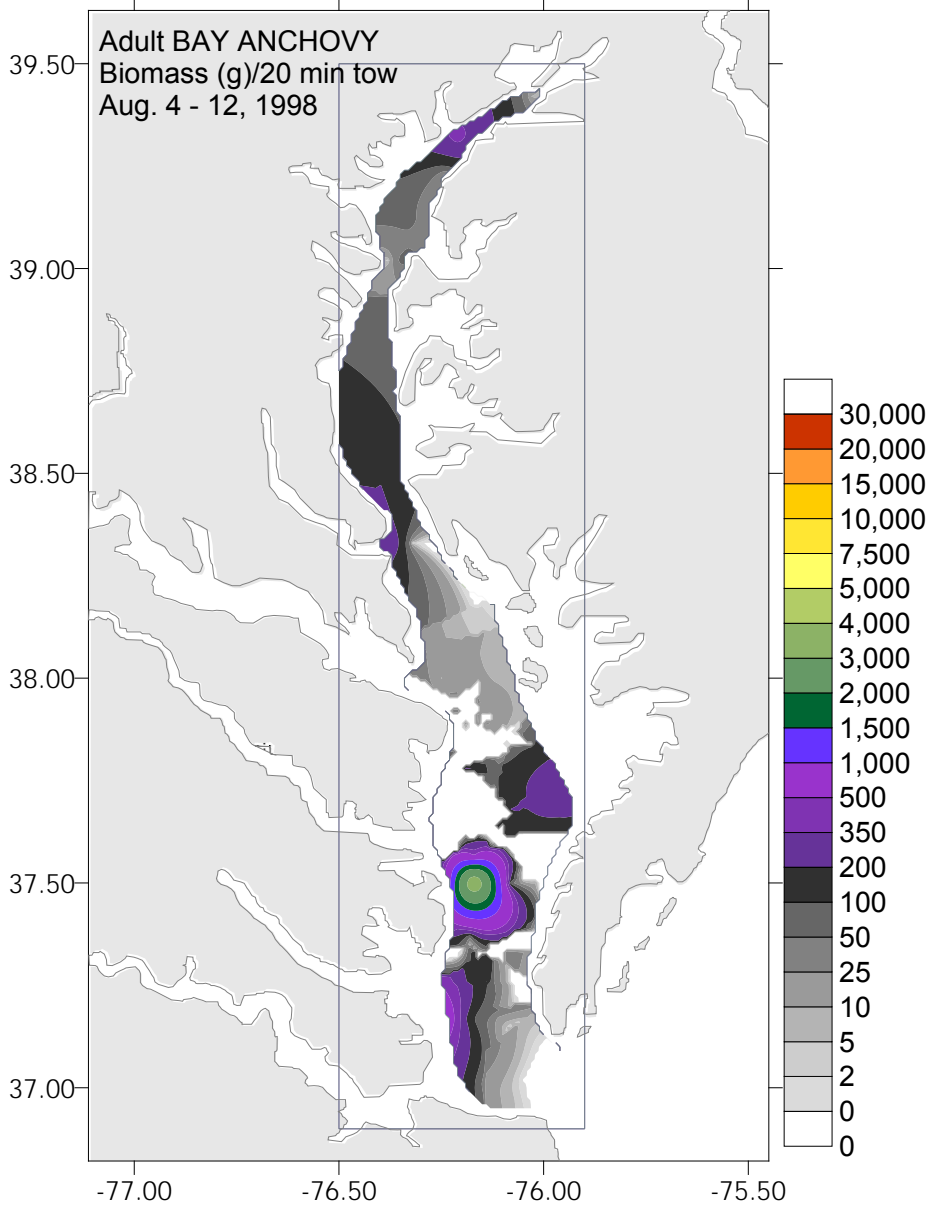

Converting relative biomass measured by MWT to absolute biomass

- Estimate the nominal water volume sampled by a MWT tow
 1. Tucker trawl with a flow meter was deployed at the same MWT stations to catch anchovy
 2. Adjustment of the MWT gear selectivity by body size of anchovy after comparing with Tucker trawl catch
 3. Converting relative anchovy biomass estimates to absolute estimates by comparing with egg production method

2-m² Tucker Trawl

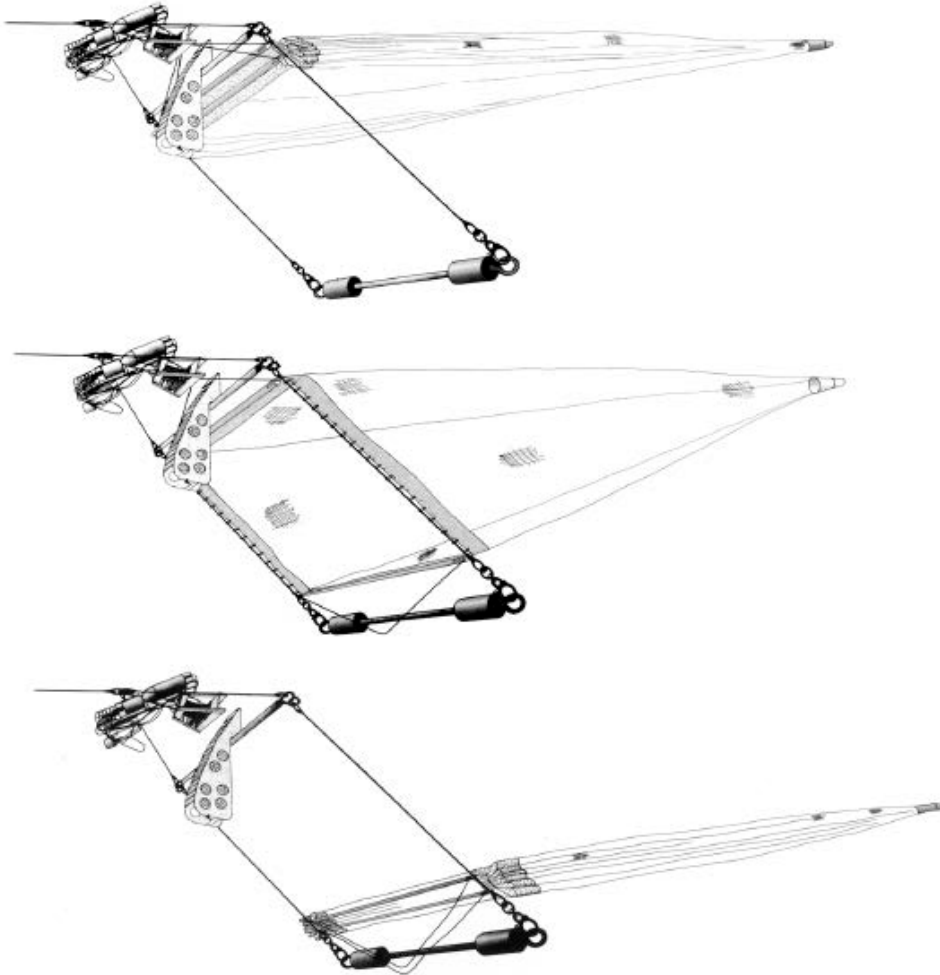

1. 707- μm mesh to catch larval and juvenile anchovy
2. Flow-meter attached to estimate water volume sampled by the Tucker Trawl



Tucker Trawl vs. Mid-water trawl

Comparison of MWT and 2 TT

Bay anchovy from NSF973

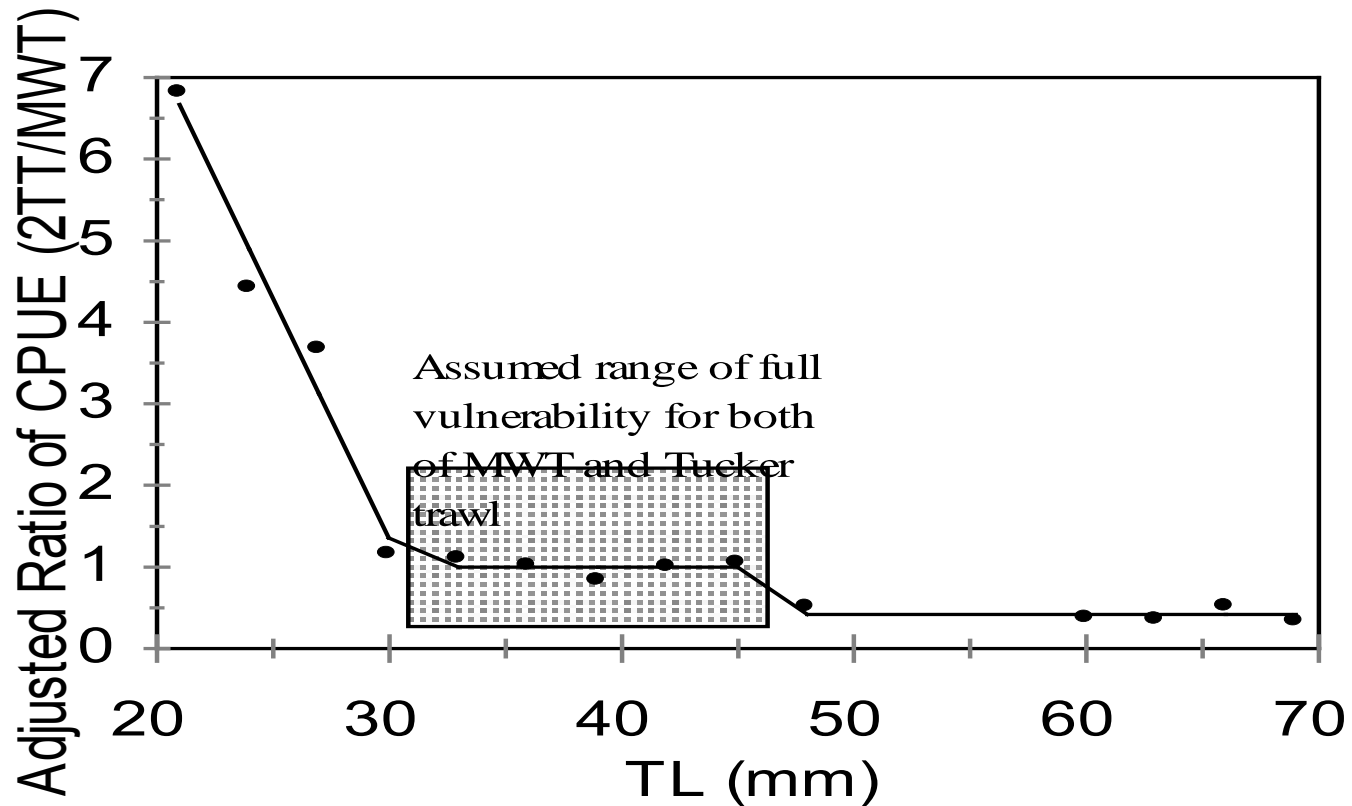

(Weighting Factor) = $-0.59 \text{ TL} + 19.08$ for of anchovy ≤ 30 mm TL

Calculating V_{MWT}

(effective water volume sampled by a
20-min MWT tow)

- $D_N = N_{MWT}/V_{MWT} = (1/s) \cdot N_{TT}/V_{TT}$.
- Then, $V_{MWT} = s \cdot (N_{MWT}/N_{TT}) \cdot V_{TT}$
 - D_N : concentration of 31-48 mm TL bay anchovy at a station (i.e., number/m³)
 - N_{MWT} : number of 31-48 mm TL bay anchovy collected per 20 min MWT tow
 - N_{TT} : number of 31-48 mm TL bay anchovy collected by the 2-m² Tucker trawl at the same station
 - s : vulnerability to the Tucker trawl ($s = 1$ if all bay anchovies in water volume, V_{TT} , are collected)
 - V_{TT} : volume filtered by the Tucker trawl (m³) estimated from a flowmeter

Egg Production Method (EPM)

- $P_0 = (B \cdot R) \cdot F$
 - P_0 : Daily egg production (number/day)
 - B : Biomass of the entire stock (male + female)
 - R : Proportion of the stock that is egg-producing females
 - F : Batch fecundity (number of eggs spawned per batch per unit weight of female)
- $B = P_0 / (R \cdot F)$: EPM
 - $P_t = P_0 e^{-Z \cdot t}$
 - $P_0 = P_t e^{Z \cdot t}$
 - P_t : observed number of eggs at age t
 - t : time after birth (spawning)
 - Z : instantaneous rate of egg mortality
 - Estimate of B is highly sensitive to Z

Varying ratio of trawl biomass to EPM biomass of bay anchovy

Cruise period		Number of stations	SSB (tons)		Biomass density (g m ⁻³)		
Year	Month		EPM	MWT	EPM	MWT	Ratio
1995	July	38	3,964	1,964	0.15	0.07	2.02
1996	July	26	1,592	488	0.06	0.02	3.26
1997	July	43	27,528	4,208	1.03	0.16	6.54
1998	August	46	18,005	2,820	0.68	0.11	6.38
1999	June	35	17,395	2,109	0.65	0.08	8.25
2000	July	26	4,497	1,233	0.17	0.05	3.65
Average		36	12,163	2,137	0.46	0.08	5.02

The regional estimates of spawning stock biomasses (SSB, tons) of bay anchovy by EPM and MWT in Chesapeake Bay during summer, and averaged for 1995-2000.

Region	Volume (x 10 ¹² m ³)	SSB (tones)		Biomass density (g m ⁻³)		
		EPM	MWT	EPM	MWT	Ratio
Lower	26.6	8,475	1,131	0.319	0.042	7.73
Mid	16.8	3,233	562	0.192	0.033	4.29
Upper	8.6	456	445	0.053	0.051	0.87

EPM:MWT ratio tended to be higher in the lower bay where spawning activity was greater (higher temperature).

V_{MWT} adjusted by EPM

- $V_{MWT} = 4,961 \text{ m}^3$, if 30-48 mm TL bay anchovy did not significantly avoid the mouth of the 2- m^2 Tucker trawl (i.e., $s = 1$).
→ Estimate **relative** biomass of anchovy
- $s = 20\%$ when compared with the Egg Production Method → Estimate **absolute** biomass of anchovy
- Effective water volume sampled by a MWT tow = **989 m^3**

Back-calculated (a) standing stock biomass and (b) daily production of young-of-the-year bay anchovy *Anchoa mitchilli* from 1995 to 2000 in Chesapeake Bay, USA

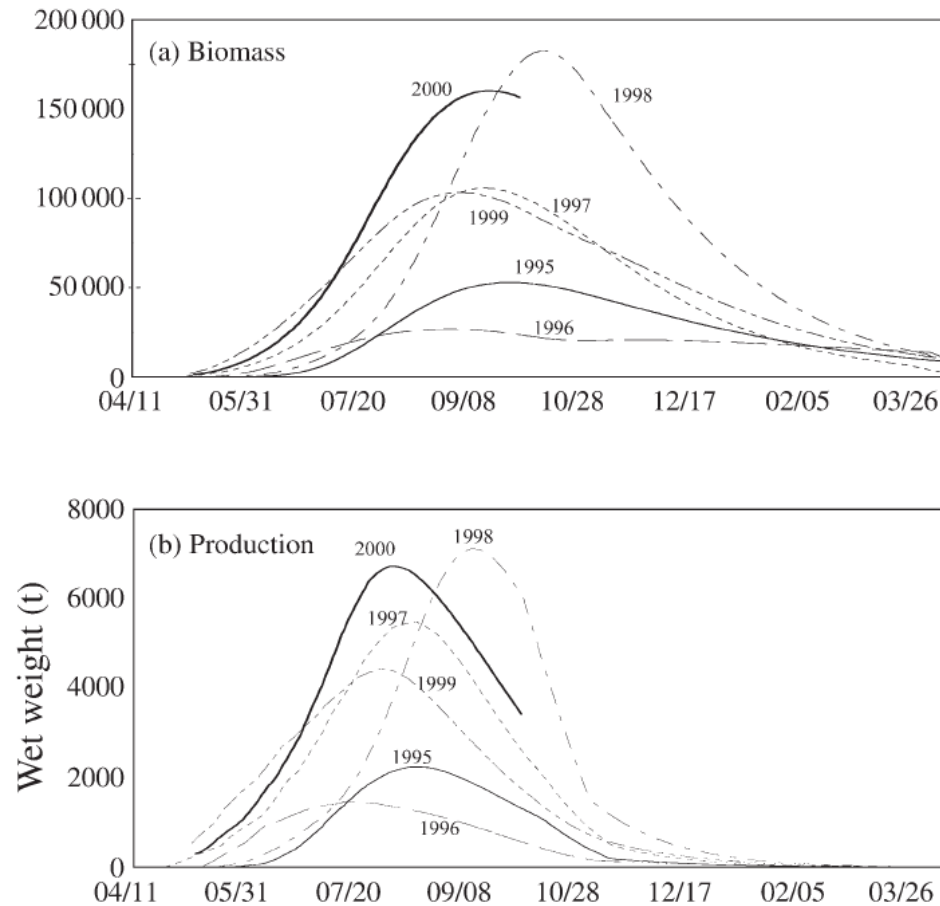

Jung, S and Houde, ED. 2004. Production of bay anchovy *Anchoa mitchilli* in Chesapeake Bay: application of size-based theory. Mar Ecol Prog Ser 281, 217-232.

Korea Strait

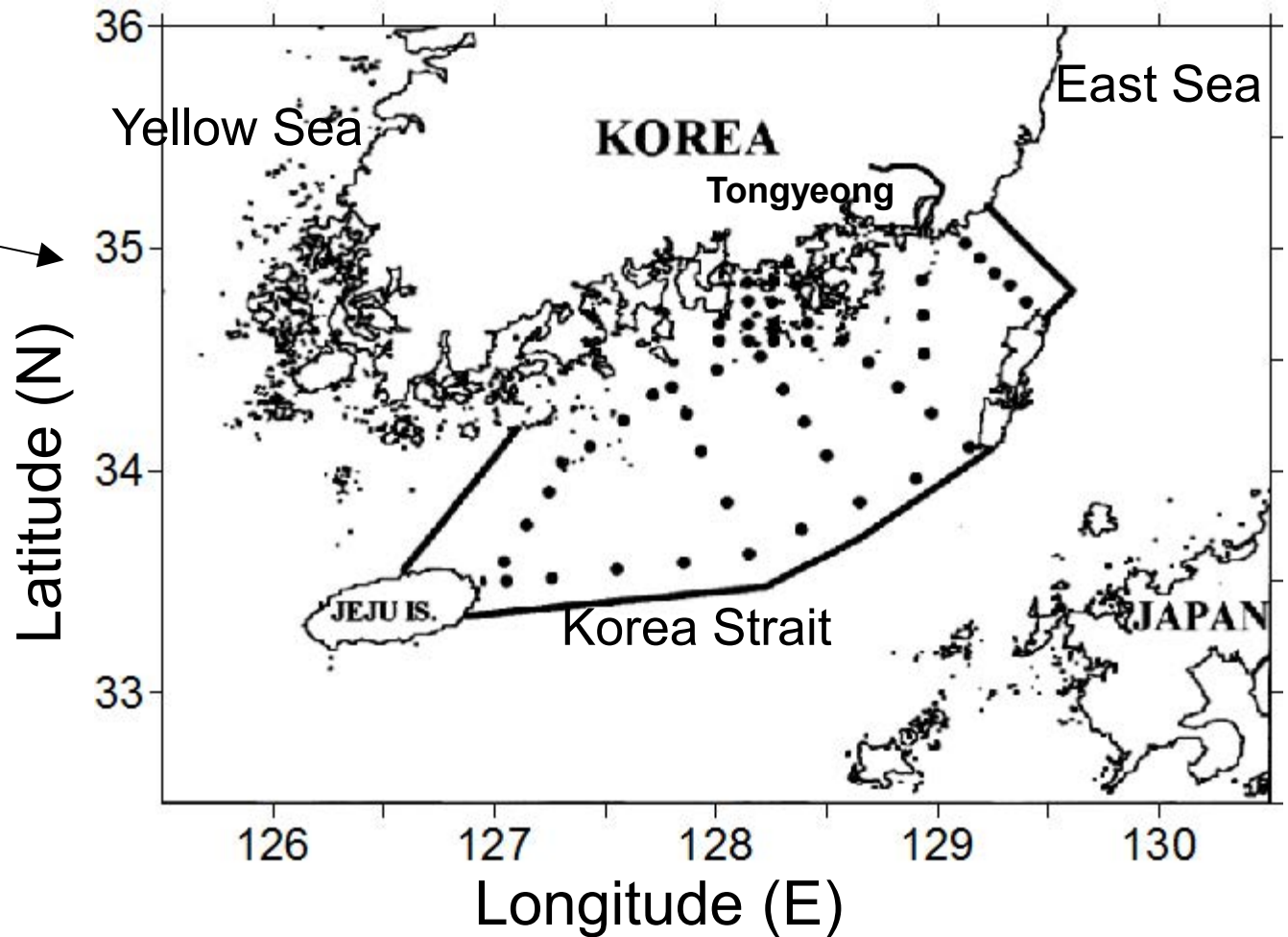
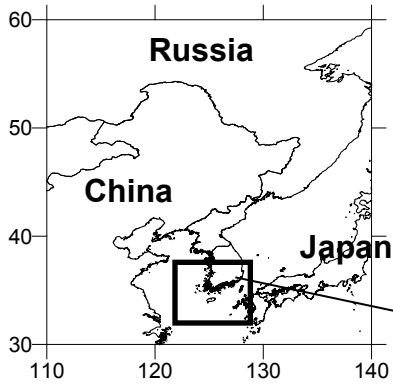

Aggregated Commercial Catch in Biomass of Anchovy (1984-2010)

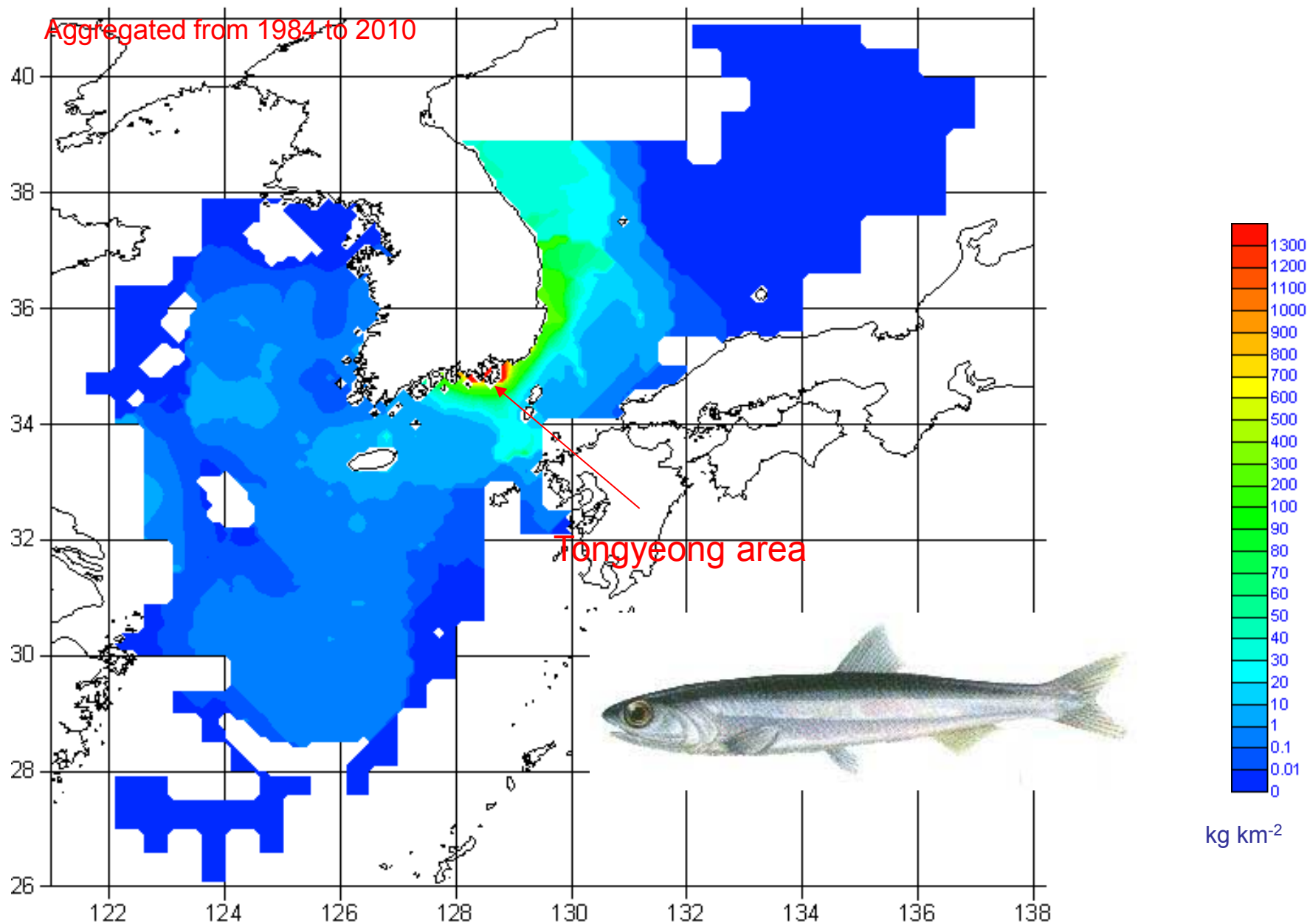

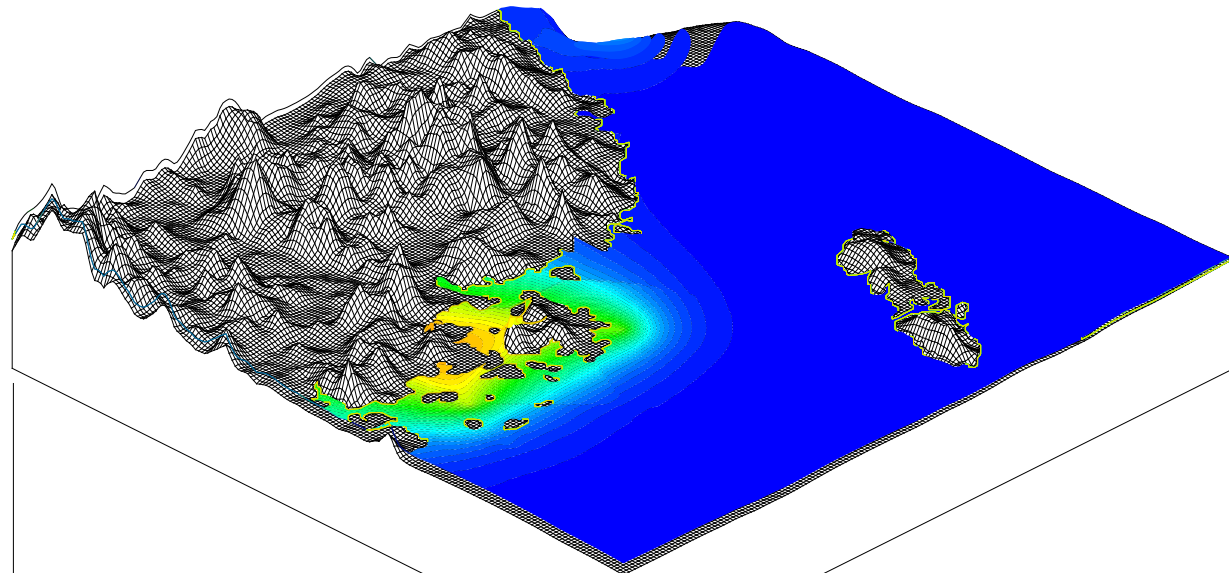

Mean catch of anchovy (1983-2005)

unit: kg km⁻² month⁻¹

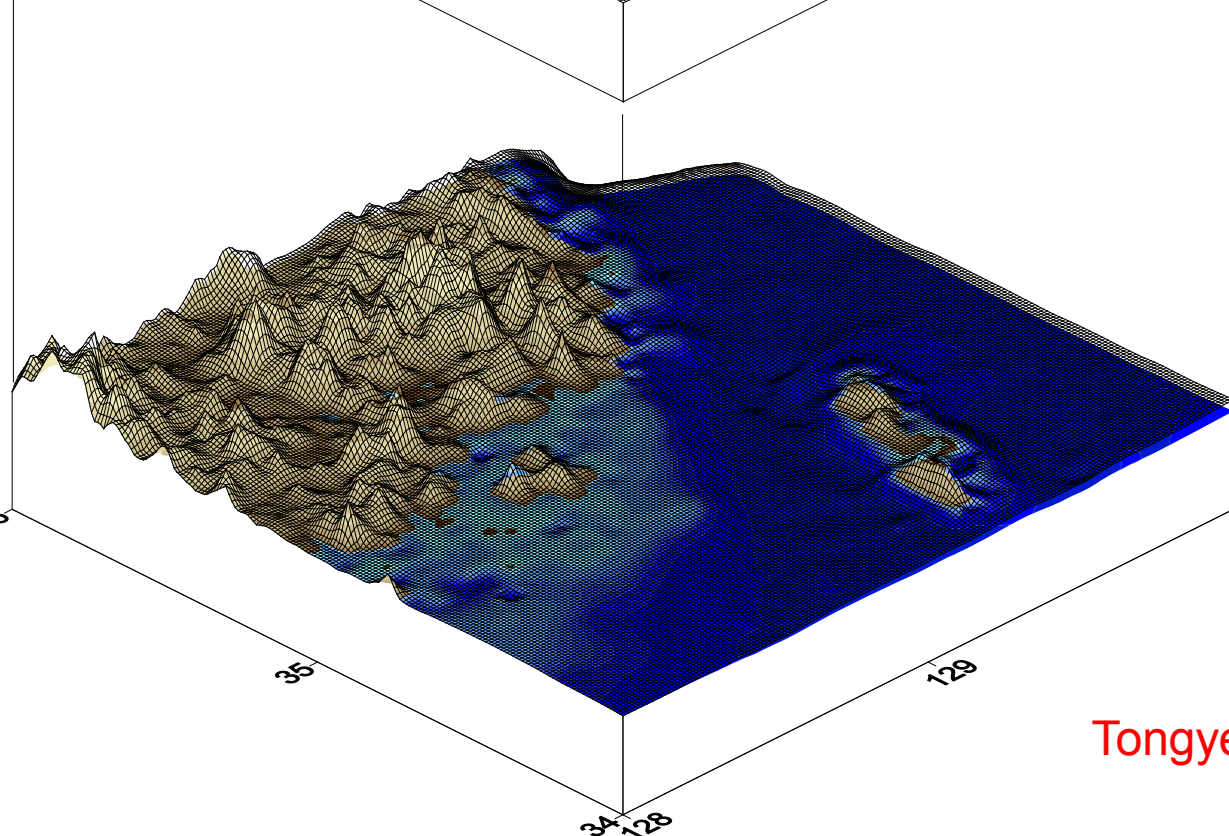
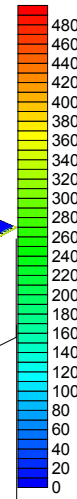

Geomorphology

Elevation/Depth (m)

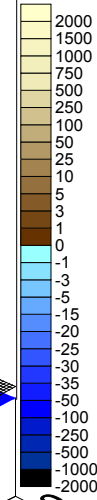

Tongyeong coastal area

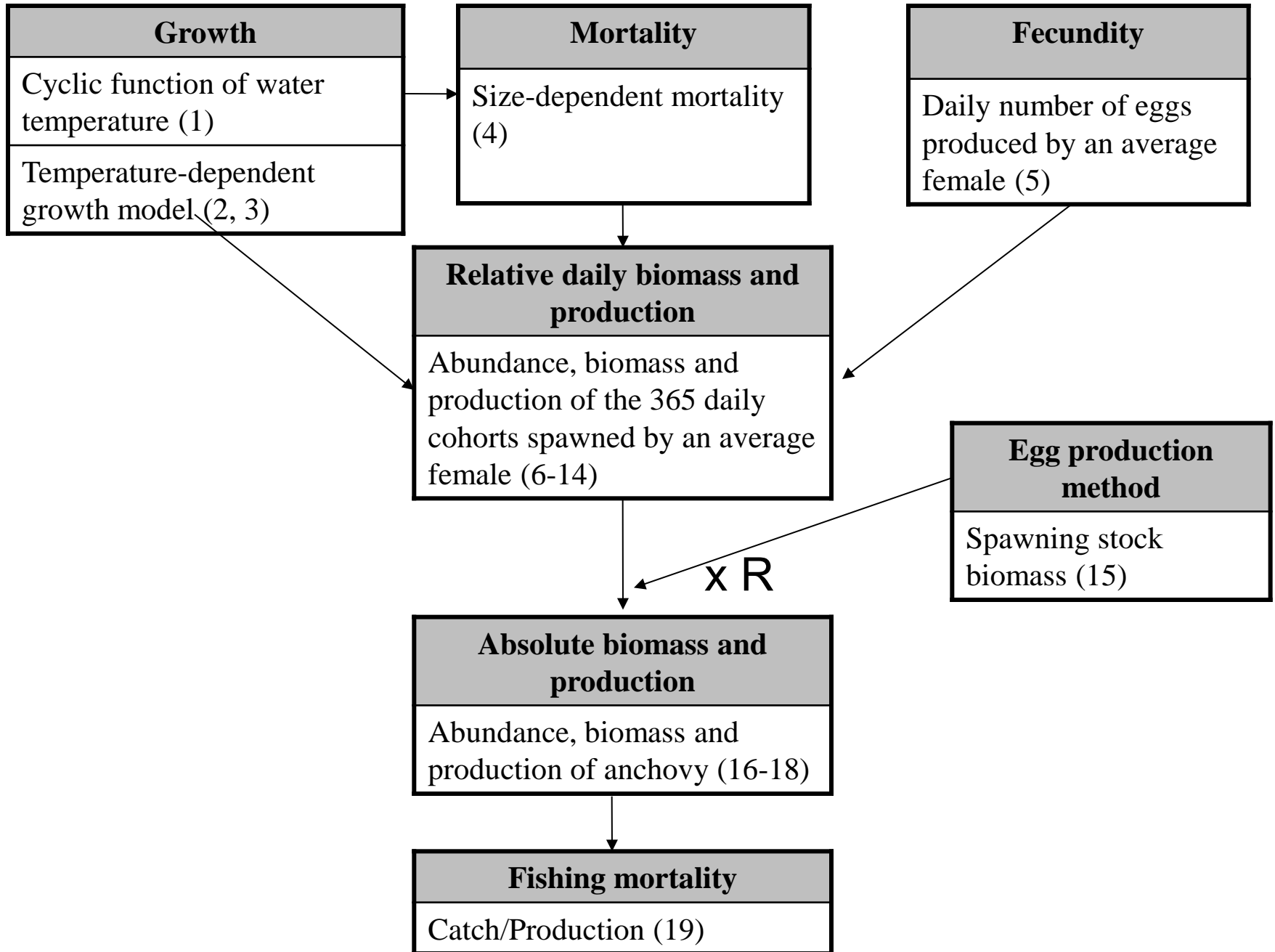

Estimated daily biomass and potential daily production of Pacific anchovy, *Engraulis japonicus* in the Korea Strait.

S. Jung / Fisheries Research 93 (2008) 280–288

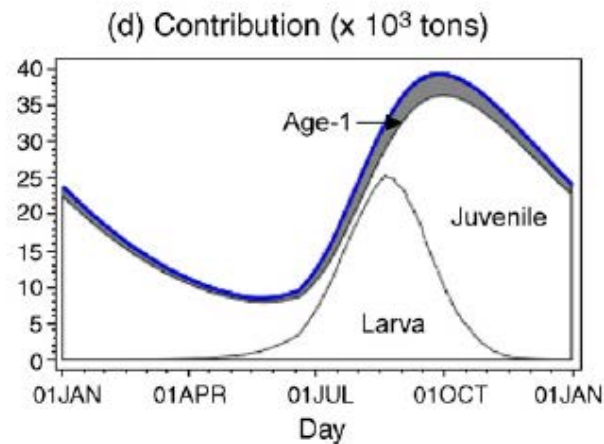
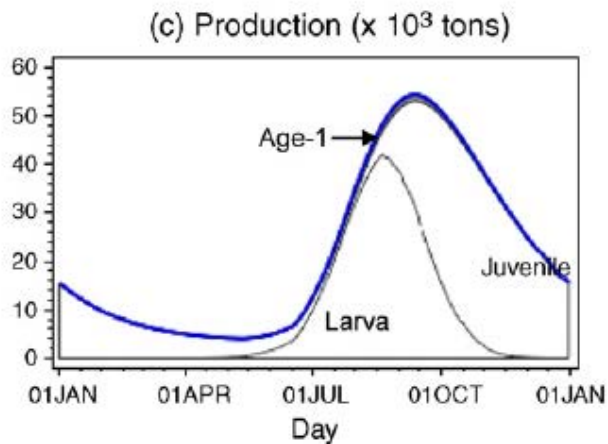
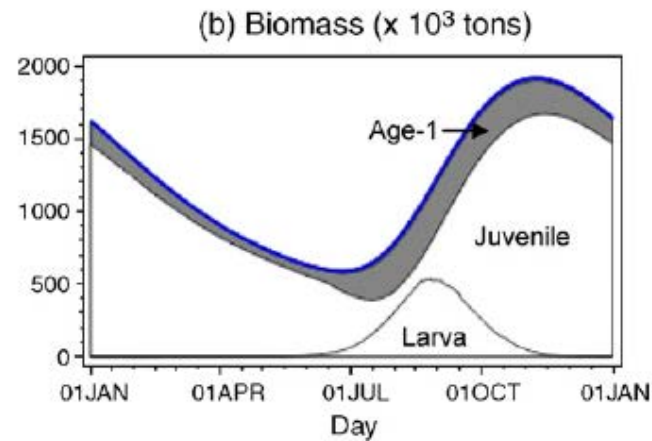
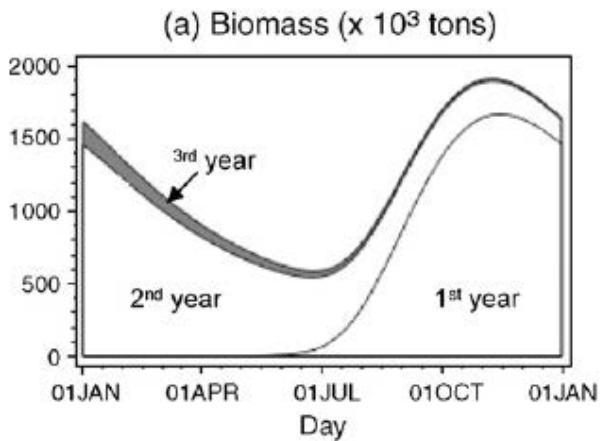

Jung, S. 2008. Simulation-based daily cohort analysis of Pacific anchovy (*Engraulis japonicus*) in southern Korean coastal waters. Fish Res 93, 280-288.

Mean biomass density of
anchovy in the Korea Strait

$$= 0.83 \text{ g m}^{-3}$$

$$= 53.3 \text{ g m}^{-2}$$

Comparison of Anchovy Biomass Estimates Chesapeake Bay vs. Korea Strait (Bay anchovy vs. Pacific anchovy)

Author	Area	Method	Size or age range	Mean density (g m ⁻³)	Peak density (g m ⁻³)
Luo & Brandt (1993)	Mid Chesapeake Bay	Acoustics	YOY > 40 d old		1.56
Wang & Houde (1995)	Upper and Mid Chesapeake Bay	Acoustics	40-76 mm in fish length	1.22	2.97
Jung & Houde (2004b), Present study	Entire Chesapeake Bay	MWT/EPM	YOY > 0 day old	0.83	2.06
Jung (2008), Present Study	Korea Strait	EPM	YOY > 0 day old	0.70	1.15

Comparison of Anchovy Biomass Estimates Korea Strait vs. Tongyeong (EPM vs. Acoustics)

Authors	Method	Region	Max depth (m)	Body size	Biomass density (g m ⁻²)					Average
					Mar	Apr-May	May	Jun	Jul	
Choi et al. (2001)	Acoustics	KS	140	> 7 cm FL	8.48	5.17				6.83
Kim et al. (2008)	Acoustics	Tongyeong	70	5-10 cm BL			116.67	106.35	344.44	189.15
Jung (2008)	EPM & Simulation	KS	140	0.15-16.4 cm FL	33.76	45.05	30.84	28.27	32.87	
Ratio (Greater/Less)					8.72	8.71	3.78	3.76	10.48	27.71

The differences are acceptable considering highly-aggregated commercial catch in Tongyeong area.

Dominance of anchovy

- Chesapeake Bay
 - bay anchovy accounted for ca. 75% of trawlable biomass of fishes.
- Korea Strait
 - Pacific anchovy accounted for ca. 57% of the total commercial catch of fishes in the KS from 2001 to 2008
 - Pacific anchovy accounted for only 15% of total fish and invertebrate biomass collected by set net from March to December 2003 in a coastal area of the KS
- The lower dominance of anchovy in the KS suggests that the degree of interference and biases introduced by other fish species whose target strength was similar to Pacific anchovy could have been greater in the KS than in Chesapeake Bay, explaining in part the higher variability of acoustic estimate in the KS.

Conclusions

- Biomass estimates by trawl or acoustics could be biased considerably (by a factor of 10)
- Validation after comparison with other independent methods
- Despite great variability, nominal estimates by trawl, egg production method and acoustics seem compatible and reliable for the purpose of stock assessment.

Ocean Sci. J. (2014) 49(2):115-126
<http://dx.doi.org/10.1007/s12601-014-0012-y>

Available online at <http://link.springer.com>

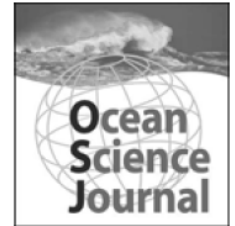
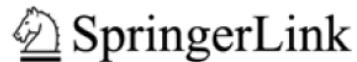

Article

Comparison of Anchovy Biomass Estimates Measured by Trawls, Egg Production Methods and Hydro-acoustics in the Chesapeake Bay and the Korea Strait

Sukgeun Jung^{1*} and Edward D. Houde²

¹*Department of Marine Life Sciences, School of Marine Biomedical Sciences, Jeju National University, Jeju 690-756, Korea*

²*Chesapeake Biological Laboratory, Center for Environmental Science, University of Maryland, P.O. Box 38, Solomons, MD 20688, USA*

Received 23 April 2014; Revised 16 May 2014; Accepted 29 May 2014

© KSO, KIOST and Springer 2014

Abstract – We compared estimates of anchovy biomass derived from trawl surveys, egg production method (EPM)

1. Introduction

Ongoing and Future works

- Other acoustic methods
 - Dual Frequency Identification Sonar (DIDSON)
- Mid-water trawl surveys in the Korea Strait
- International cooperative researches (Japan, China and USA)
- Individual-based models for predicting spatio-temporal variability of Pacific anchovy in the western North Pacific

Acknowledgement



Korea Environment Institute

Jeju Sea Grant