



Looking Back to Go Forward

Jacquelynn King

Pacific Biological Station, Fisheries and Oceans Canada, Nanaimo

Science Board Symposium

PICES Annual Meeting

Oct. 16-26, Yeosu, Korea

The PICES' Science Road Trip

1. *Where did we start?*

- *revisit the early years of PICES*

2. *Travel the PICES-GLOBEC CCCC Program*

- *the major accomplishments*

3. *Meander towards the FUTURE Program*

- *momentum from CCCC to FUTURE*

4. *Stumble a bit in the wilderness*

- *the first five years of FUTURE*

5. *Where we are now*

- *what is the progress of FUTURE so far?*

6. *The road ahead*

- *what should we focus on?*



1. Start: The Early Years of PICES

The 1st Annual Meeting, 1992;
Warren Wooster's Opening Address
PICES Annual Report 1992

PICES' Overarching question:

“What is the nature of the subarctic Pacific ecosystem (or ecosystems), and how is it affected over periods of months to centuries by changes in the physical environment, by interactions among components of the ecosystem, and by human activities? “



1. Start: The Early Years of PICES

The 1st Annual Meeting, 1992;
Warren Wooster's Opening Address
PICES Annual Report 1992

- **Logistical approach to answering the question:**

"...the problems are all interconnected and that the study of each depends to some degree on, or contributes to, studies of the others."

- requires interdisciplinary research and communication between researchers

- **Role in the international arena**

"PICES is not in competition with other international organizations nor with established international programs. Instead, we should find ways to complement and support such organizations and programs to the extent they relate to our objectives."

- coordinate to international programs



1. Start: The Early Years of PICES

Sara Tjossem. 2005. *The Journey to PICES*

- 1992 1st Annual Meeting
 - FIS
 - POC
 - MEQ } defined their Working Groups, set out scientific workplans
- BIO – no specific scientific programs
- the Scientific Committees were very much discipline focused, not immediately integrated
- logistically needed Integrated Science Program
 - 1993: two PICES Working Groups outlining how to link PICES efforts to the international GLOBEC Program

2. PICES – GLOBEC collaboration



- GLOBEC, a study of Global Ocean Ecosystem Dynamics, was initiated in 1990 by the Scientific Committee on Oceanic Research (SCOR) and the Intergovernmental Oceanographic Commission (IOC) of UNESCO, and incorporated into the International Geosphere-Biosphere Program (IGBP) Core Element structure in 1995.
 - *“To advance our understanding of the structure and functioning of the global ocean ecosystem, its major subsystems, and its response to physical forcing so that a capability can be developed to forecast the responses of the marine ecosystem to global change”.*

2. PICES – GLOBEC collaboration

GLOBEC Regional Programs

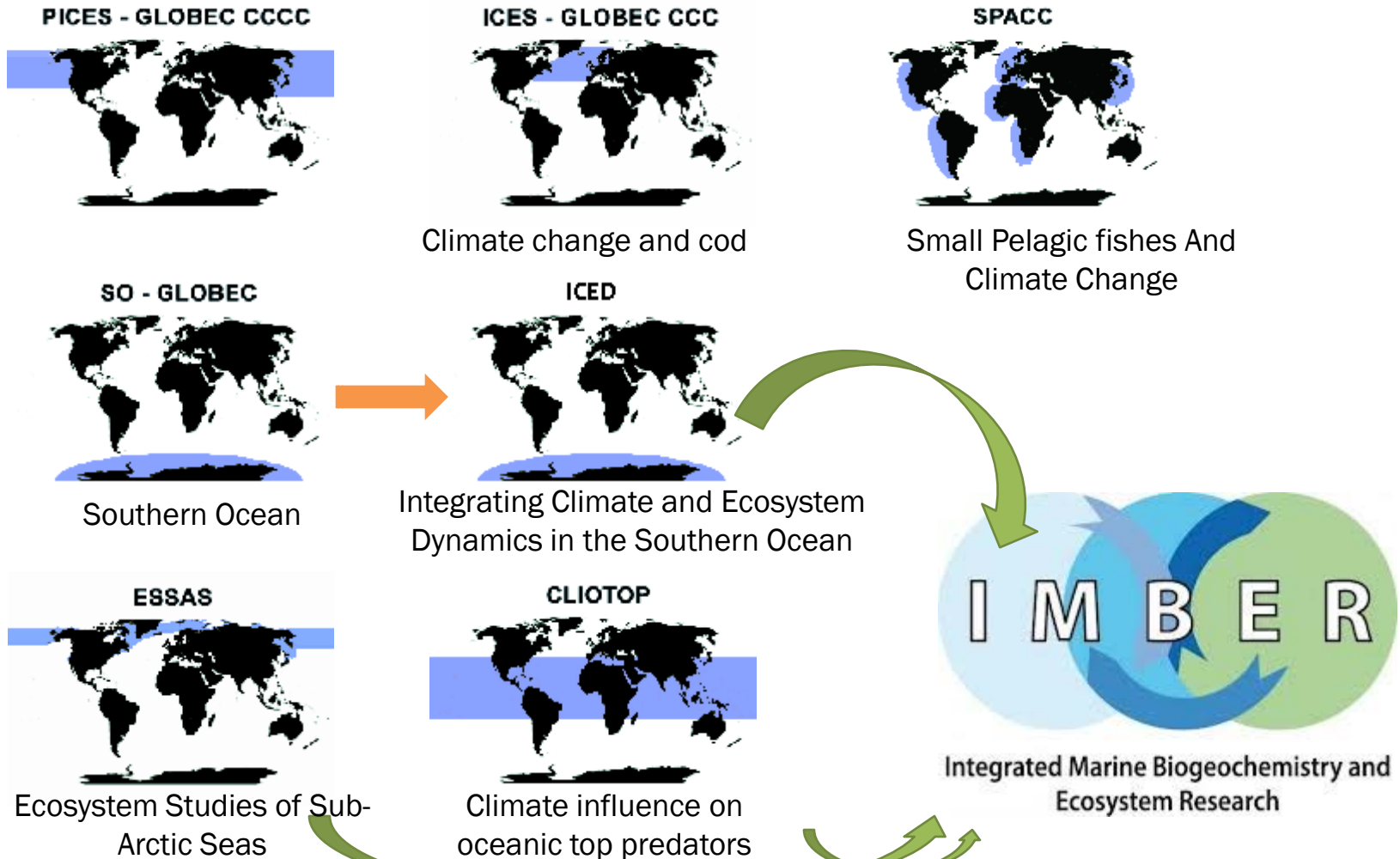



2. PICES – GLOBEC CCCC

Climate Change and Carrying Capacity

Batchelder and Kim. 2008. *Progr. Oceanogr.* 77

The First PICES' Science Program

- 1995-2009
 - Primary goal:
 - to examine how climate change and variability affect ecosystem structure, and the productivity of key biological species at multiple trophic levels in both the oceanic and neritic regions of the North Pacific
 - Ultimate goal:
 - to forecast the consequences of climate variability on the ecosystems of the North Pacific



2. PICES – GLOBEC CCCC

Integrated Structure

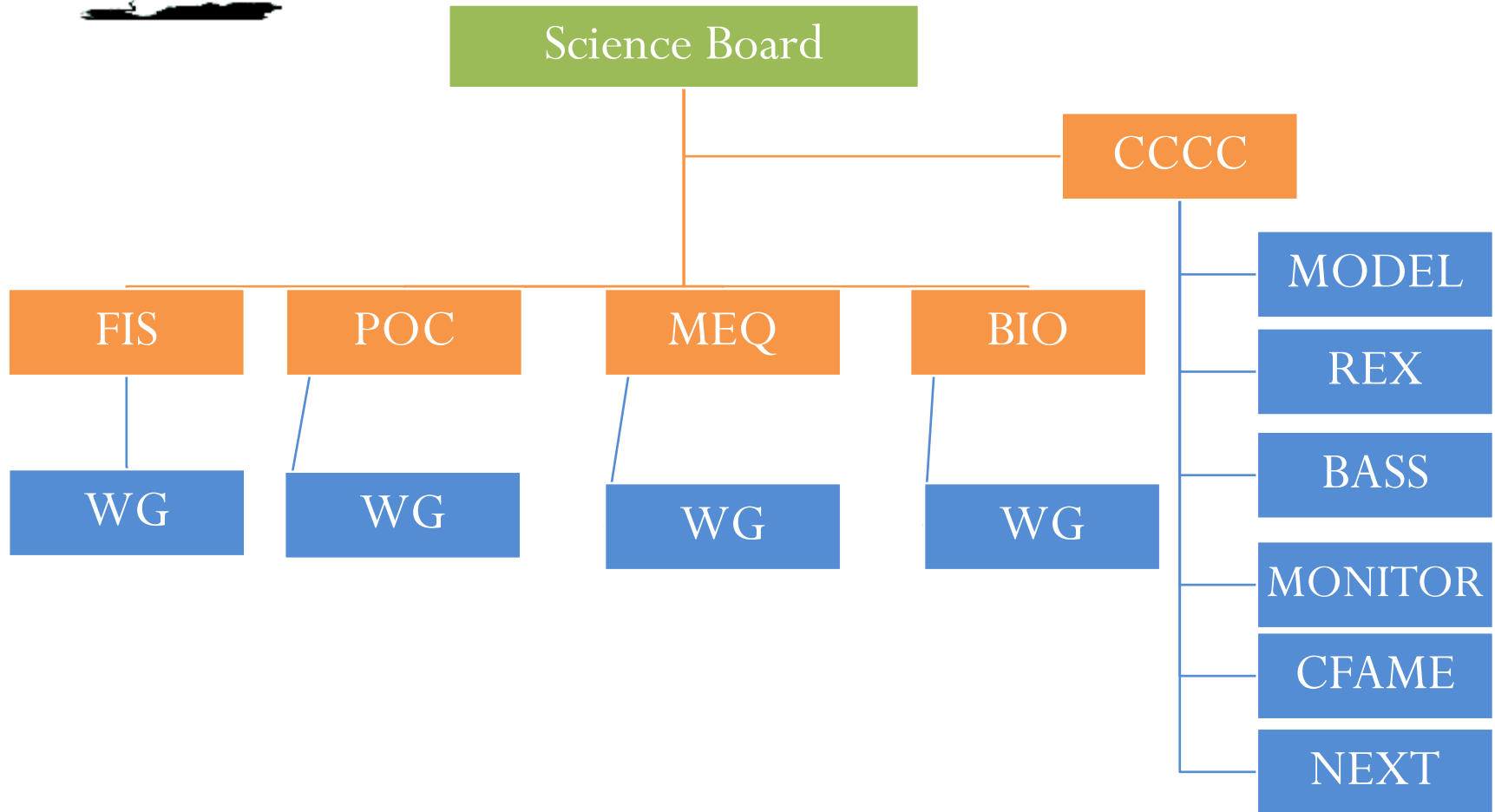



2. PICES – GLOBEC CCCC

Task Team Major Accomplishments

- **Product =**
 - new research
 - database
 - monitoring program
 - model
 - conceptual mechanism or scenario buildingthat would not have been completed if CCCC (or the Task Team) did not exist

≠ research or output

that is completed by PICES members and would have been completed anyways if CCCC did not exist



2. PICES – GLOBEC CCCC

Task Team Major Accomplishments

Perry, Hollowed, Sugimoto. 2002. PICES Sci. Rep. 22

- Conceptual Theoretical and **Modeling** Studies Task Team (MODEL)– 1995-2009
 - ★ NEMURO – **N**orth Pacific **E**cosystem **M**odel for **U**nderstanding **R**egional **O**ceanography

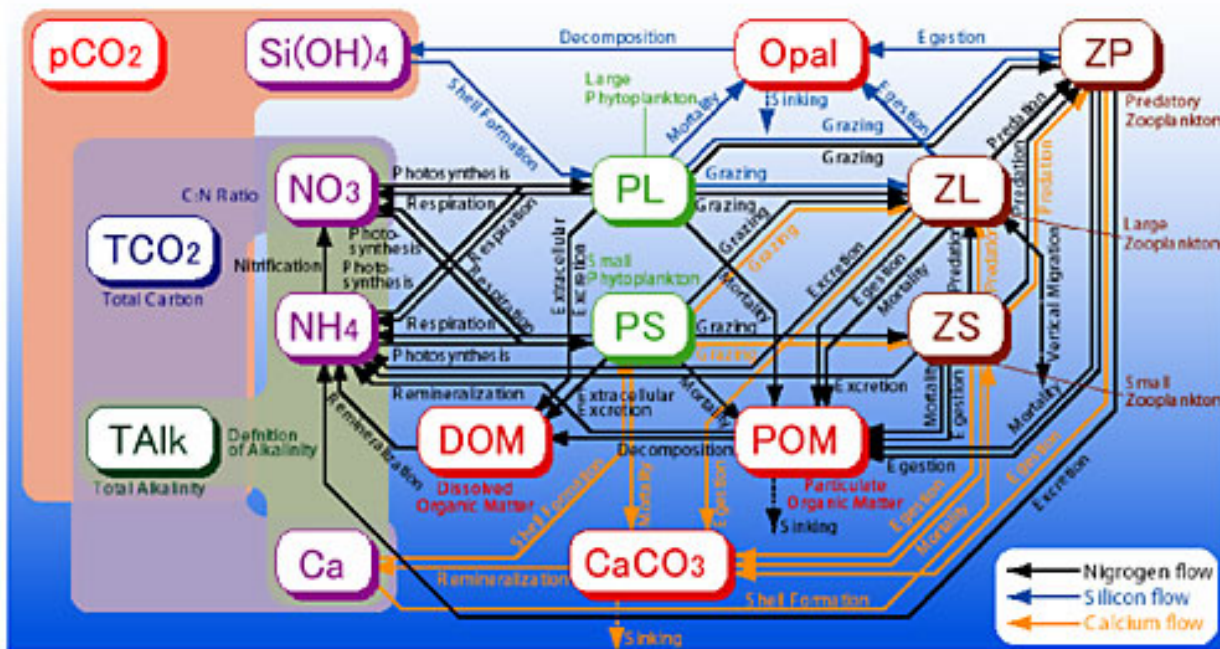



2. PICES – GLOBEC CCCC

Task Team Major Accomplishments

Perry, Hollowed, Sugimoto. 2002. PICES Sci. Rep. 22

- **Regional Experiments Task Team (REX)**– 1996-2004
 - ★ sessions and workshops related to herring led to a database
 - ★ NEMURO.FISH (herring, saury, sardine, salmon)

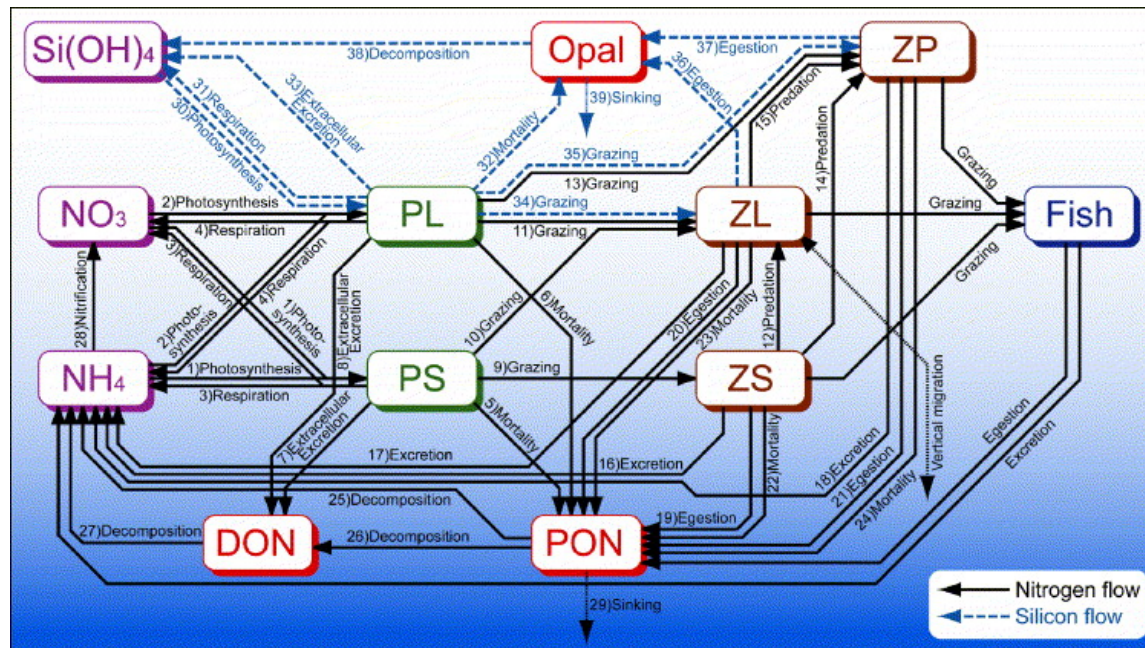



2. PICES – GLOBEC CCCC

Task Team Major Accomplishments

Perry, Hollowed, Sugimoto. 2002. PICES Sci. Rep. 22

- **Basin Studies Task Team (BASS)– 1995-2004**
 - ★ established basin-scale linkages in ecosystem dynamics in the North Pacific
 - 1999. Ecosystem Dynamics of the Eastern and Western Gyres of the Subarctic Pacific. Progr. Oceanogr. 43

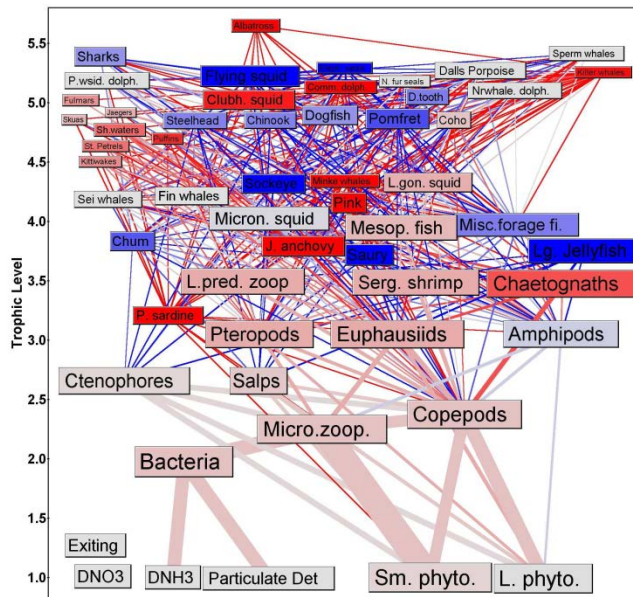

- ★ ECOSIM model of the Sub-Arctic Gyre with description of food web structure for the Western and Eastern Sub-Arctic Pacific



2. PICES – GLOBEC CCCC

Task Team Major Accomplishments

Perry, Hollowed, Sugimoto. 2002. PICES Sci. Rep. 22

- **Monitoring** Task Team (MONITOR)– 1997-2004
 - ★ established the Continuous Plankton Recorder (CPR) program in the North Pacific

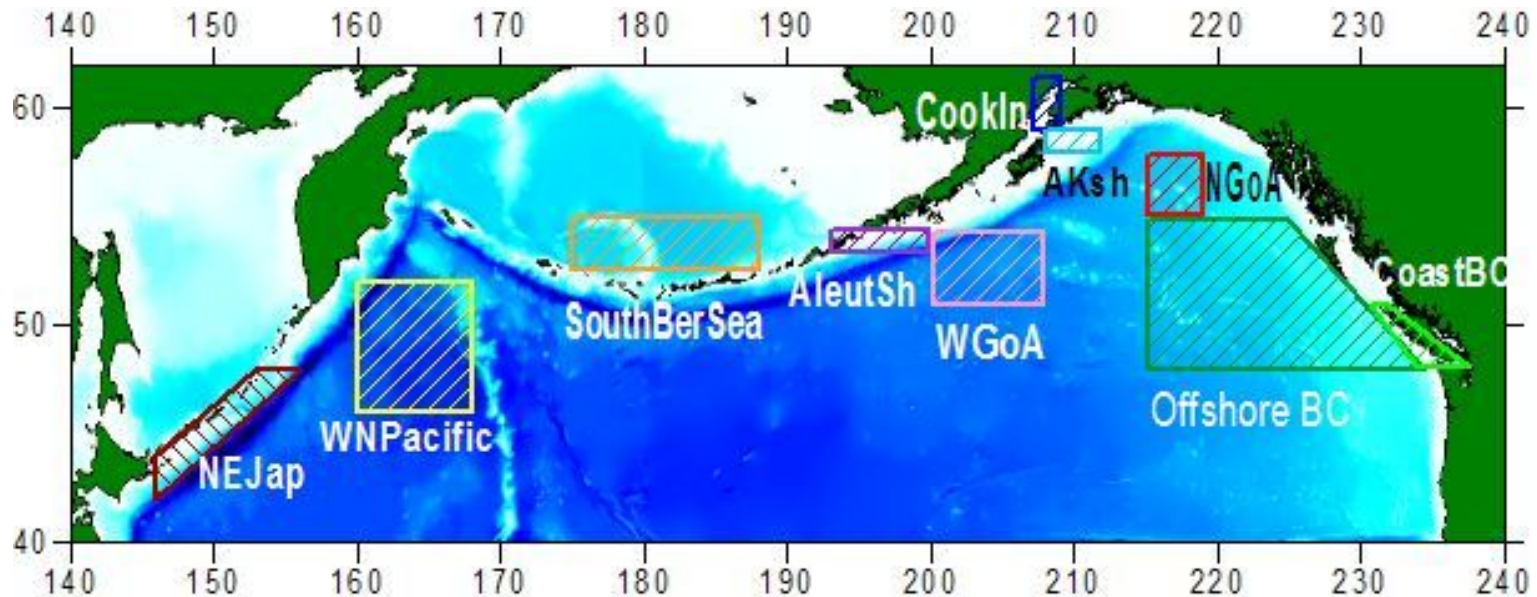



2. PICES – GLOBEC CCCC

Task Team Major Accomplishments

- **C**limate **F**orcing and **M**arine **E**cosystems Task Team (CFAME)–
Central 2004-2009

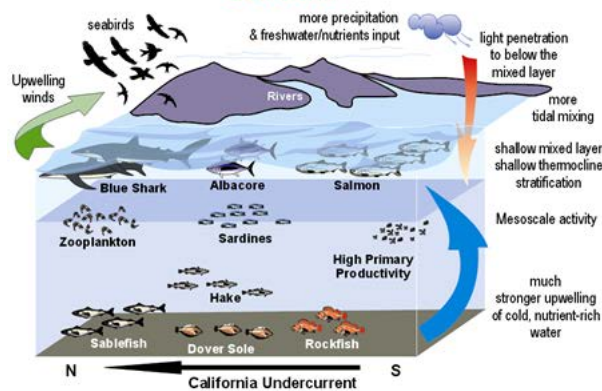

- ★ conceptual mechanisms linking climate to higher trophic levels through physics
 - mechanisms based on species biology and life stage

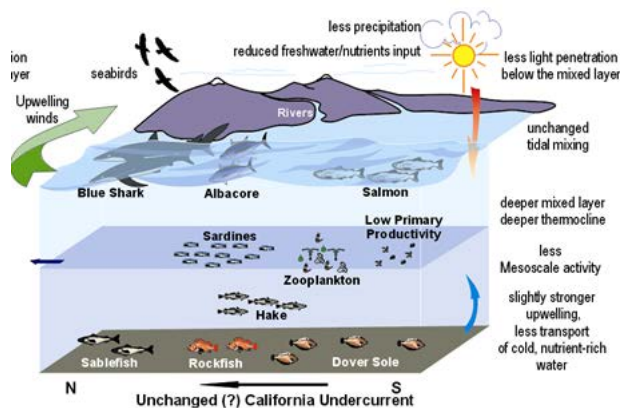

- ★ scenarios of ecosystem change under climate warming for California Current System (King et al. 2011), Kuroshio/Oyashio System (Yatsu et al. 2013) and the Yellow/East China Sea



2. PICES – GLOBEC CCCC

Rating CCCC Success

Batchelder and Kim. 2008. *Progr. Oceanogr.* 77

1. What are the characteristics of climate variability, can interdecadal patterns be identified, and how and when do they arise?
 - **Climatology and Physical oceanography**
2. How do primary and secondary producers respond in productivity, and in species and size composition, to climate variability in different ecosystems of the subarctic Pacific?
 - **Biological oceanography**
3. How do life history patterns, distribution, vital rates, and population dynamics of higher trophic level species respond directly and indirectly to climate variability?
 - **Species level**
4. How are subarctic ecosystems structured? Do higher trophic levels respond to climate variability solely as a consequence of bottom-up forcing? Are there significant intra-trophic level and top-down effects on lower trophic level production and on energy transfer efficiencies?
 - **Ecosystem level**



2. PICES – GLOBEC CCCC

Rating CCCC Success

Batchelder and Kim. 2008. *Progr. Oceanogr.* 77

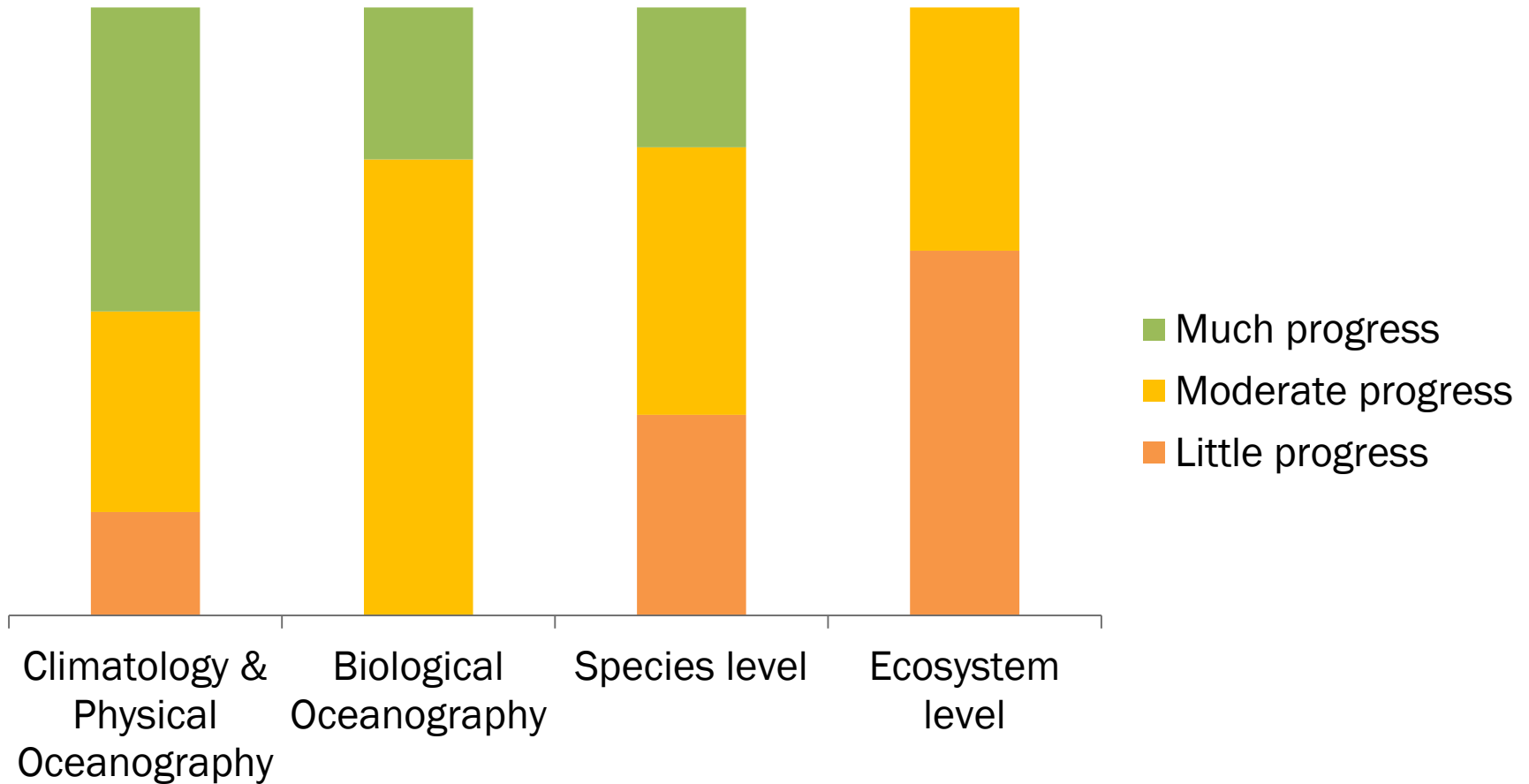



3. From CCCC to FUTURE

The new Science Program

- GLOBEC ended in 2009 – no umbrella for PICES Science Plan
- Study Group on Future Integrative Scientific Program(s) 2005-2009
 - FUTURE Science Plan Writing Team 2007-2008: What are we going to do?
 - FUTURE Implementation Plan Writing Team 2008-2009: How are we going to do it?

Forecasting and **U**nderstanding **T**rends,
Uncertainty and **R**esponses of North Pacific
Marine **E**cosystems (Oct 2009 -)



3. From CCCC to FUTURE

The new Science Program

“What is the future of the North Pacific given current and expected pressures?”

1. What determines an ecosystem’s intrinsic resilience and vulnerability to natural and anthropogenic forcing?
2. How do ecosystems respond to natural and anthropogenic forcing, and how might they change in the future?
3. How do human activities affect coastal ecosystems and how are societies affected by changes in these ecosystems?

“How can forecasts, uncertainty and consequences of ecosystem change be communicated effectively to society?”



4. First half of FUTURE

Implementation: How to do the work

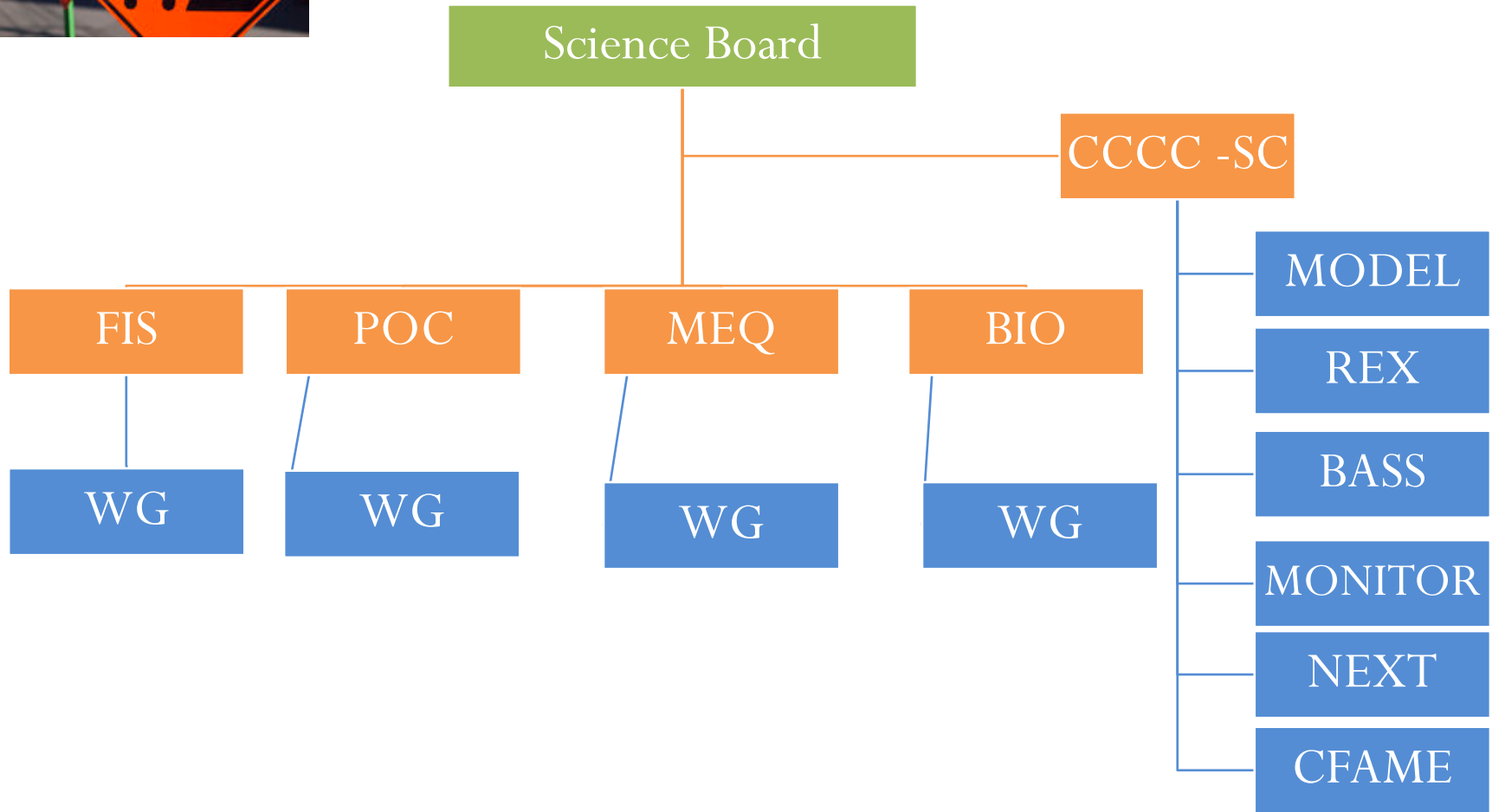



4. First half of FUTURE

Implementation: How to do the work

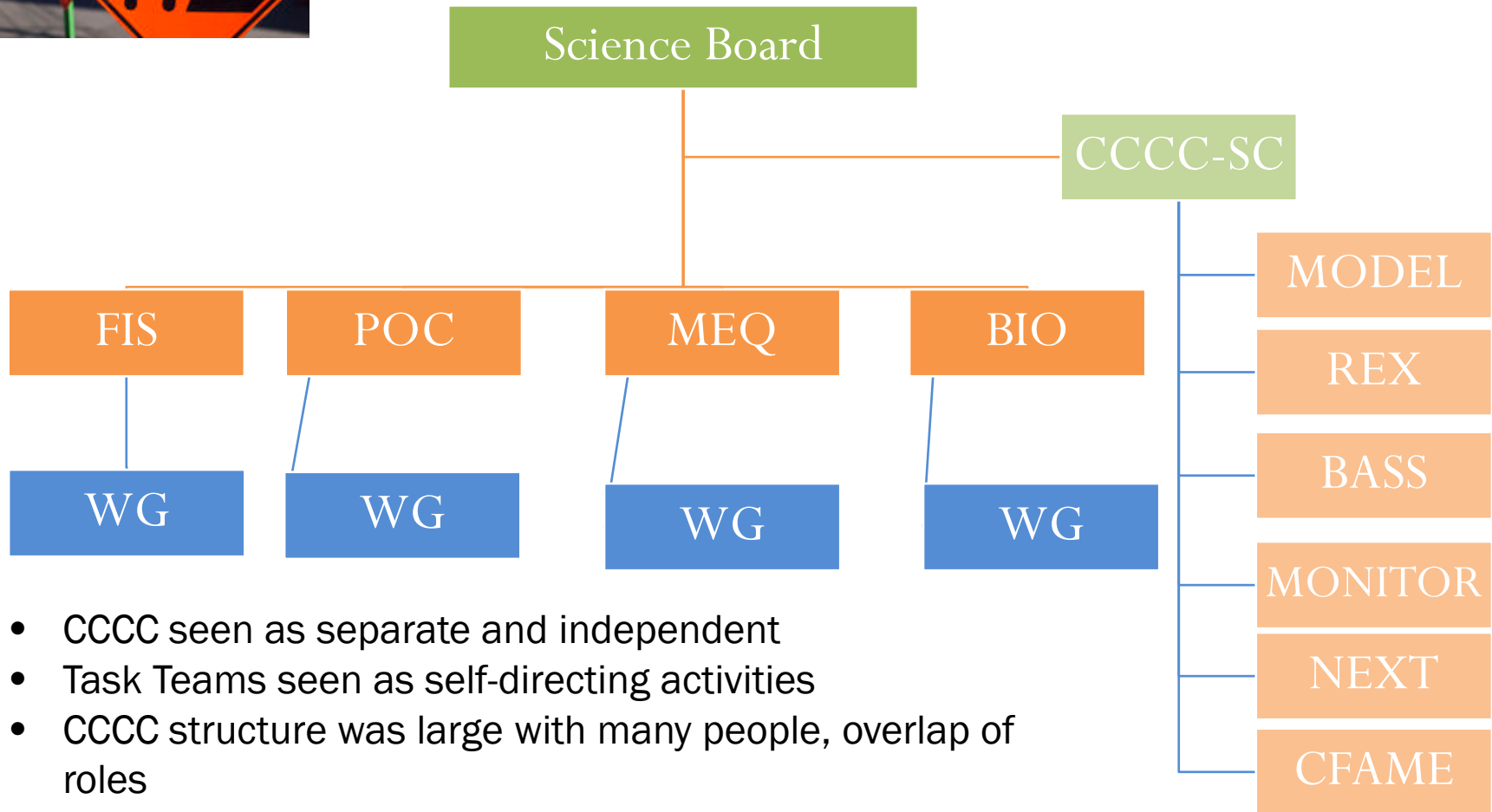



4. First half of FUTURE

Implementation: How to do the work

- Science Board is the Steering Committee of FUTURE
- Advisory Panels do not strike EX-G only advise

Anthropogenic
Influences on
Coastal Ecosystems



Climate, Ocean
Variability and
Ecosystems

Status, Outlooks, Forecasts and
Engagement



4. First half of FUTURE

Implementation: How to do the work

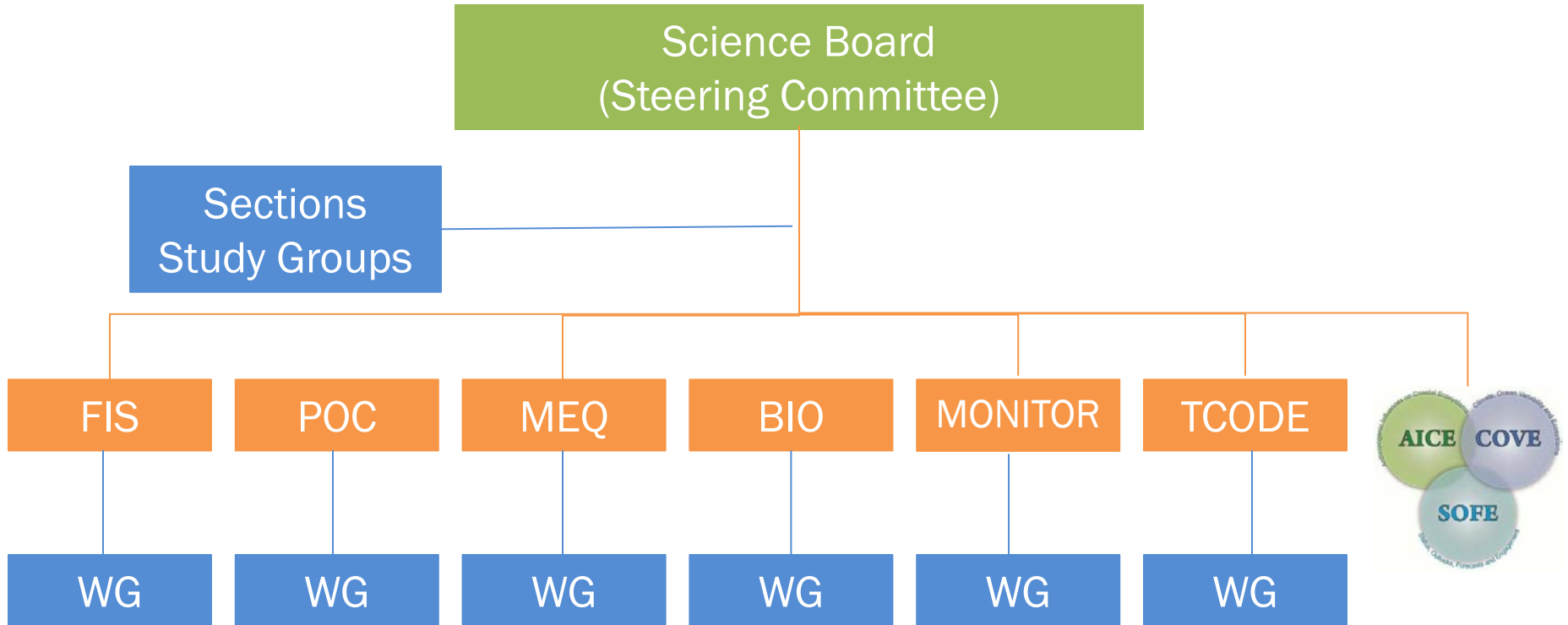



4. First half of FUTURE

Work Underway

- New **Working Groups** established specifically to address components of FUTURE:
 - WG 27: *North Pacific Climate Variability and Change*
 - WG 28: *Development of Ecosystem Indicators to Characterize Ecosystem Responses to Multiple Stressors*
 - WG 29: *Regional Climate Modeling*
 - WG-30: *Assessment of Marine Environmental Quality of Radiation around the North Pacific*
 - WG-31: *Emerging Topics in Marine Pollution*
- FUTURE also led to the creation of two new **Sections**:
 - Section on *Climate Change Effects on Marine Ecosystems*
 - Section on *Human Dimensions of Marine Systems*
- and also the **Study Group**:
 - SG-SEES: *Socio-Ecological-Environmental Systems*



5. Mid-way in FUTURE

Where are we now?

- FUTURE Open Science Meeting (Hawaii, April 2014)
 - an appropriate time to evaluate what has been achieved and what remains to be addressed.
 - Based on information assessed at this symposium, FUTURE may redirect its course in order to achieve its final goals.
 - 8 sessions, 4 workshops, 116 Registrants
 - Social science engagement
- FUTURE Evaluation Panel
 - 6 members; 2 external
 - assessed FUTURE and
 - International Progress/Identity
 - Member States
 - Progress on Science Plan
 - report provided recommendations on a course redirection



5. Mid-way in FUTURE

Where are we now?

2014 FUTURE Evaluation Panel Report

- Ocean-Climate Forecasting (COVE related work)
 - WG 27 has
 - updated the synthesis of climate processes in the North Pacific
 - identified climate forcing functions
 - interpreted the IPCC 5th AR projections in the context of North Pacific climate dynamics
 - WG 29 has
 - completed a comprehensive review of existing RCM
 - developed new RCM in the North Pacific
 - assessed their potential and performance in downscaling



5. Mid-way in FUTURE

Where are we now?

2014 FUTURE Evaluation Panel Report

- Ocean-Climate Forecasting (COVE related work)
 - WG 27 and WG 29 work is relevant to this theme & the natural science mandate in the Science Plan is clear
 - WG 27 and WG 29 evolved from pre-existing WG, so momentum has been maintained
 - the work is inherently international and lends to PICES collaboration
 - existing and strong links to the international CLIVAR program



5. Mid-way in FUTURE

Where are we now?

2014 FUTURE Evaluation Panel Report

- Communication and outreach (SOFE related work)
 - lots of good planning so far
 - no products and a lack of infrastructure to deliver new products
- Coastal pressure and cumulative impacts (AICE related work)
 - little progress to date
 - low participation at AICE meetings
 - poor communication with the EX-G it suggested, WG 28
 - WG28 will provide progress
 - identification of best practices on quantifying pressures and impacts; assessing interaction and cumulative effects
 - lessons learned for local-scale assessment case studies
 - core suite of regional indicators



5. Mid-way in FUTURE

Where are we now?

2014 FUTURE Evaluation Panel Report

- From the Science Plan, the anticipated benefits and products of FUTURE will include:
 - ☑ Increased understanding of physical, chemical and biological linkages and ecosystem responses to anthropogenic and climate forcings;
 - ☐ Coordinated monitoring and descriptions of the current state of ecosystems;
 - ☐ Forecasts of future states of North Pacific marine ecosystems and their associated uncertainty;
 - Better quantitative and qualitative forecasts, with specified uncertainty, of ecosystem responses to climate change and increasing human influence;
 - IPCC-like reports on responses of North Pacific ecosystems to climate change;
 - An improved scientific basis for managing coastal ecosystems to sustain ecosystem services and to mitigate various environmental problems;



5. Mid-way in FUTURE

Where are we now?

2014 FUTURE Evaluation Panel Report

- From the Science Plan, the anticipated benefits and products of FUTURE will include:
 - Quantification of the benefits and risks associated with different management strategies;
 - Region-specific assessments of topical issues (e.g., harmful algal blooms, eutrophication, native and alien species range changes, anoxia, and ocean acidification);
 - Increased data sharing, access and dissemination with a focus on coordination and metadata.
 - Increased marine science capabilities in PICES member countries;
 - Increased participation in PICES of younger scientists and a greater role for social and economic scientists;**
 - Increased public awareness of the ecosystem changes in the North Pacific.



5. Mid-way in FUTURE

Where are we now?

If you find yourself asking:

“What is she talking about? The work we are doing in my Expert Group does address some of the FUTURE themes or questions.”

- then the take home message is that there is:
 - poor integration between Expert Groups;
 - poor understanding of FUTURE and the products that we need to deliver;
 - poor overall communication



6. The Road Ahead

Where to go next?

2014 FUTURE Evaluation Panel Report

1. Change the Governance structure of FUTURE

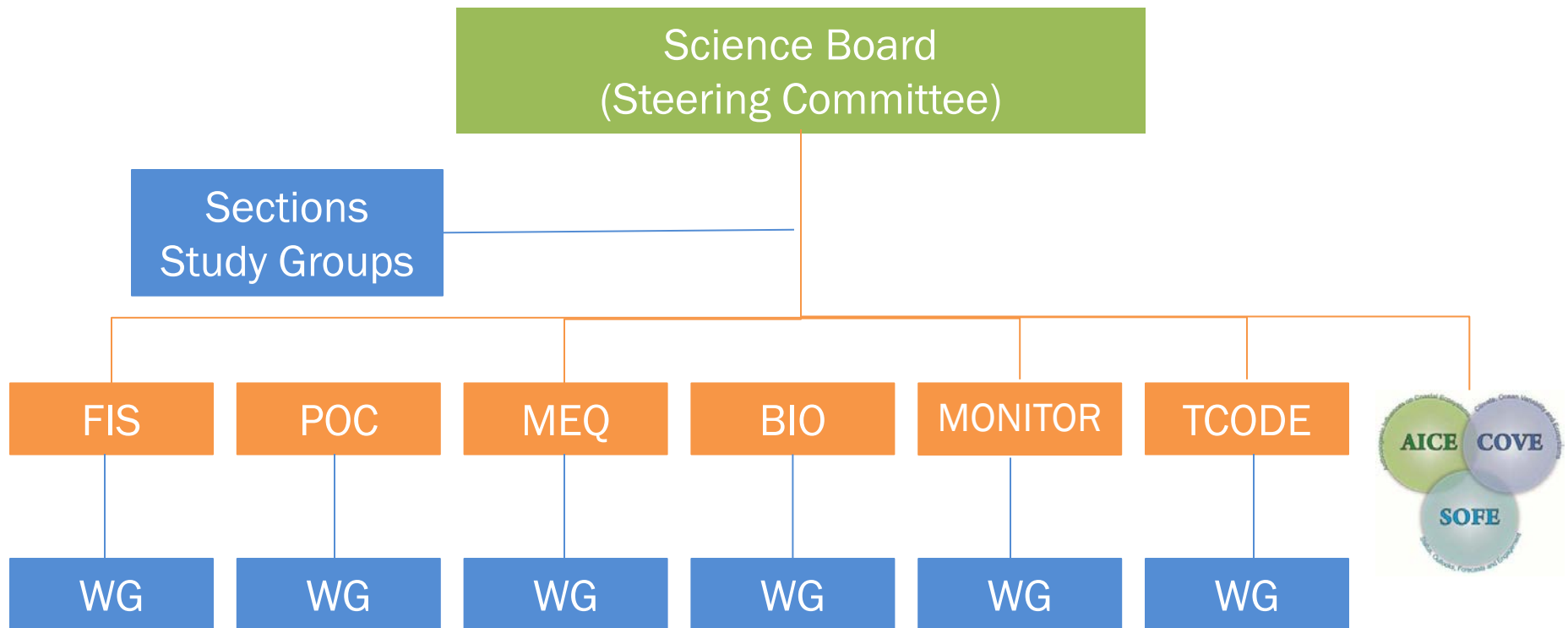



6. The Road Ahead

Where to go next?

2014 FUTURE Evaluation Panel Report

1. Change the Governance structure of FUTURE

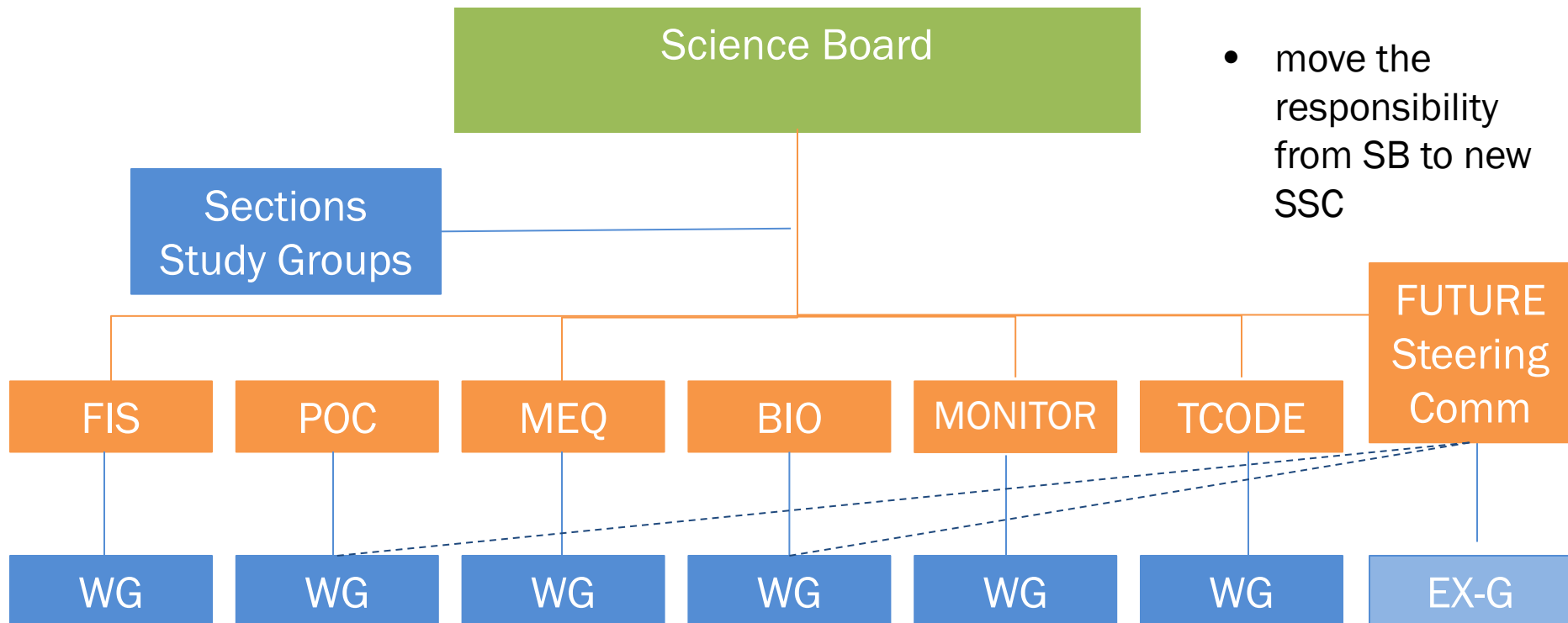

- move the responsibility from SB to new SSC

- the FUTURE SSC are enabled to strike their own EX-G or allow co-parenting with relevant WG reporting to a Committee and the FUTURE SSC



6. The Road Ahead

Where to go next?

2014 FUTURE Evaluation Panel Report

2. Improve EX-G Integration

- EX-G are for the most part, unaware of the progress and products of others and the potential for integration
- communicate with an Open Meeting at each Annual Meeting with updates by all EX-G chairs
- direct reporting required of relevant EX-G to FUTURE Scientific Steering Committee



6. The Road Ahead

Where to go next?

2014 FUTURE Evaluation Panel Report

3. Next steps for Expert Groups

- WG 29 should link with S-CCME
 - integrate its forecasts into S-CCME efforts to forecast climate change impacts on commercial fisheries
- Re-focus on NEMURO
 - Revisit the recommendations made by NEXT (NEMURO Experimental Planning Team)
- WG 28 and AICE AP (or the new SSC) need to communicate and inventory any progress in coastal assessment
 - focus best practices and core suite of indicators to selected 1-2 coastal pressures



6. The Road Ahead

Where to go next?

4. A return of dedicated Intersessional Workshops for EX-G
 - fundamental difference between CCC and FUTURE, and crucial for success
 - collaborative science requires interaction where relationships are established, trust is built in order to facilitate creativity

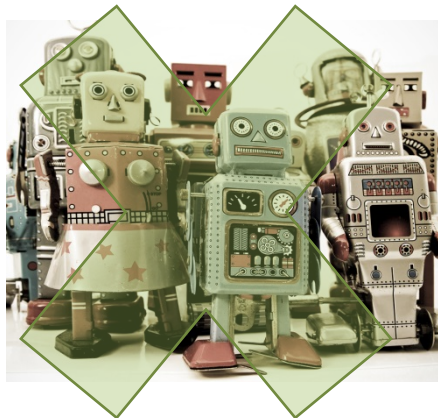



6. The Road Ahead

Where to go next?

4. A return of dedicated Intersessional Workshops for EX-G

CCCC 2003-2008

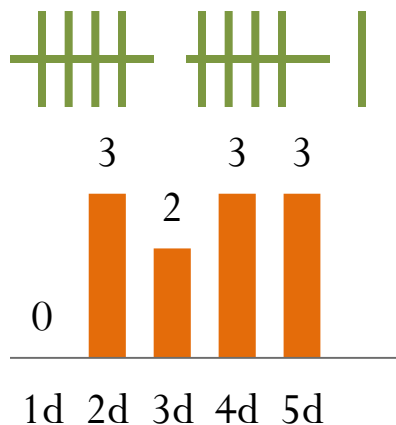

➤ longer workshops dedicated to generate products

- this is a fundamental challenge given travel restrictions and reduced budgets

FUTURE 2009-2014

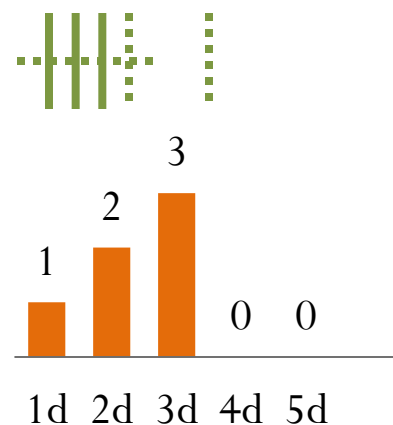

➤ shorter meetings to plan for products or synthesize existing research



6. The Road Ahead

Where to go next?

2014 FUTURE Evaluation Panel Report

5. Improve International Collaboration Specific to FUTURE

- CLIVAR
 - this integration is already strong through WG27 and WG29
 - can we select FUTURE sub-questions to continue this linkage?
- IMBER
 - this integration has not been as strong as it could be
 - can we identify areas, such as social sciences, to link with?
- ICES-PICES collaboration
 - S-CCME is an obvious linkage, and focuses well on fish
 - can we identify Joint Session themes relevant to FUTURE and beyond the fish linkage?



6. The Road Ahead

Where to go next?

6. Identify where it is that we want to go
 - prioritize sub-questions
 - prioritize anticipated benefits or outcomes
 - focus the coastal theme
 - what are 1 or 2 coastal pressures of interest to most PICES member nations?
 - hypoxia, acidification, oil spills, chemical pollution
 - build on WG28 progress
 - Our priority should be to reassess what we can accomplish (or what we are interested in accomplishing) given reduced participation and fewer dedicated workshops



“If you know where you are going, any road will get you there.”

- Lewis Carroll